



Elektrische Werte

*Bemessungsstrom 160 A
Durchgangswiderstand < 110 µOhm

Werkstoff

Kontakt Messing, versilbert

Anschluß

Anschlußart crimp
Anschlußbereich 50 mm²
Abisolierlänge 18 mm
Crimpeinstellungen sind individuell zu wählen

Mechanische Werte

Steckzyklen 500

Werkzeuge (nicht im Lieferumfang enthalten)

Crimpzangen-Set im Koffer,
komplett mit Crimpeinsätzen C0.207.00

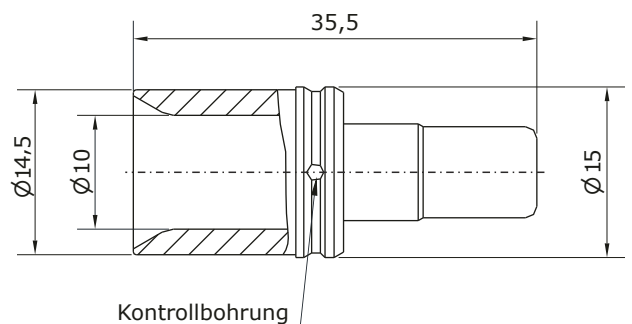
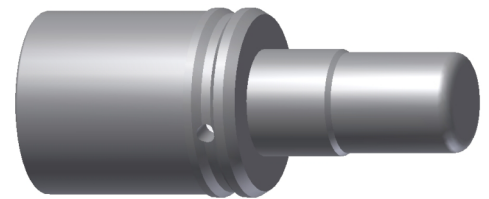

Hauptabmessungen

Kontaktbuchse





Electrical Data

*rated current 160 A
contact resistance < $110\ \mu\text{Ohm}$

Material

contact brass, silver plated

Termination

kind of termination crimp
cross section $50\ \text{mm}^2$
stripping length 18 mm
crimp settings select individually

Mechanical Data

mating cycles 500

Tools (not part of product contents)

crimping tool-set in the case complete with crimping insert order code: C0.207.00)

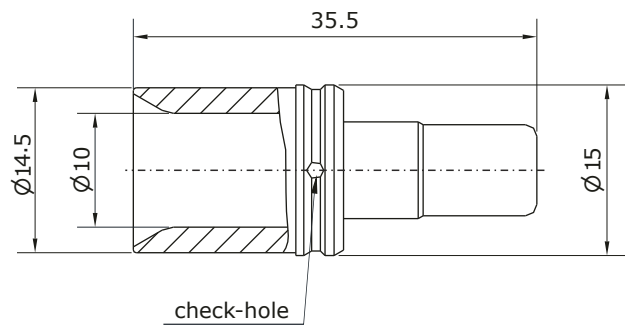
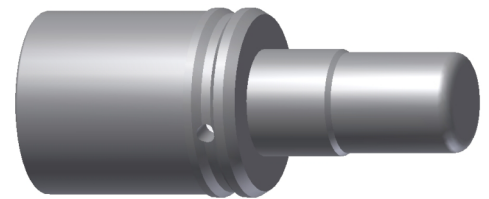

Main Dimension

contact socket

