

Alignment Unit D-Series

Part No. 500308

With the Alignment Unit it is easy to adjust the laser beam to the requested measuring target. It is made of steel, zinc-plated and can be used for any type of D-Series Laser Distance Sensor. Optional there is a Protective Cover (Part No. 500309) for this Alignment Unit available.



Technical Data

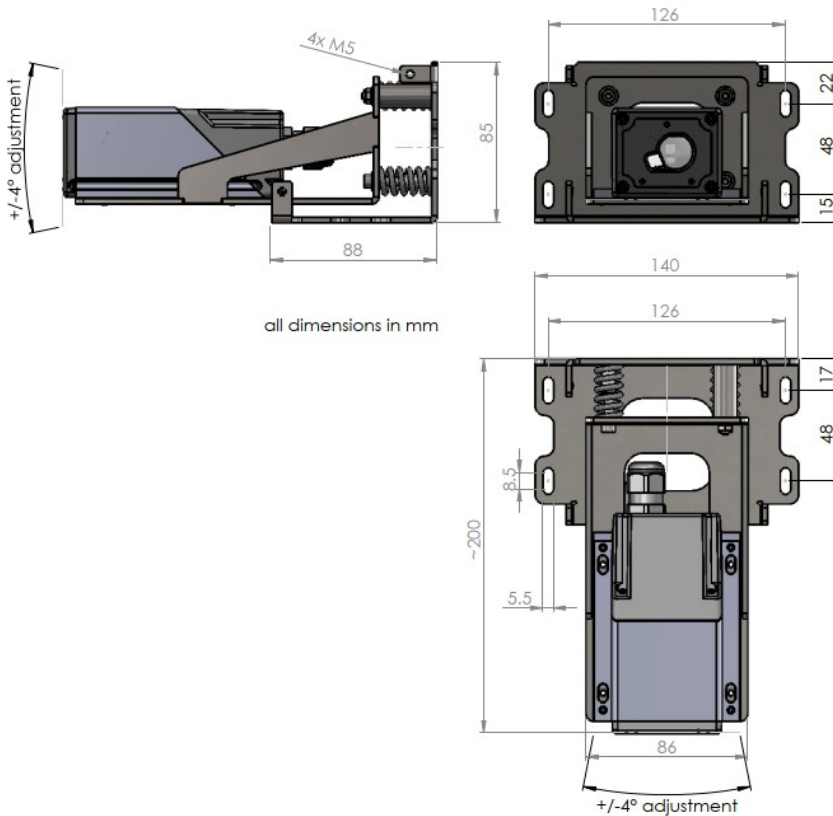

Order information

Part No.	Description
500308	<p>Alignment Unit D-Series</p> <p>Allows +/-4° adjustment in two axis; Ideal for distances up to about 300m; Steel, zinc-plated; Applicable for D-Series; Weight 850g</p> <p>country of origin: Switzerland TN:9015.9000</p>