

BEK-R70/30-G0TI-IBS-DIF

Ringbeleuchtung
Ringlight
Anneau lumineux

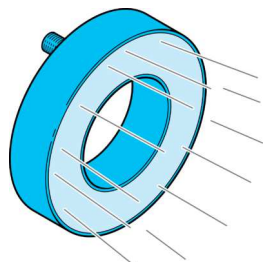

di-soric GmbH & Co. KG
Steinbeisstraße 6
DE-73660 Urbach
Germany
Tel: +49 (0) 7181/9879-0
info@di-soric.de · www.di-soric.com

206466

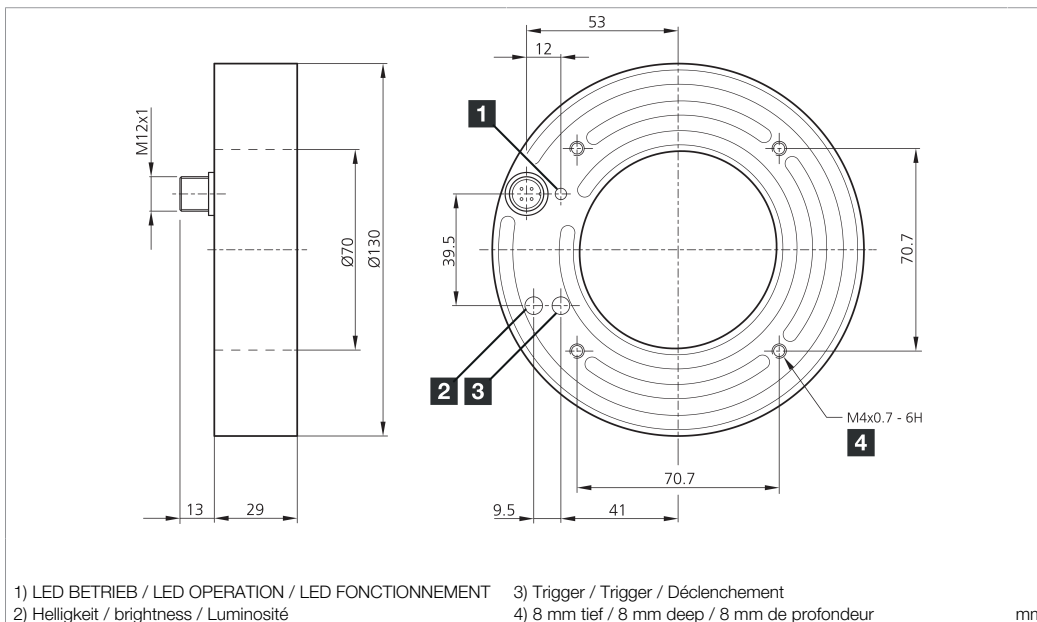

1) LED BETRIEB / LED OPERATION / LED FONCTIONNEMENT 3) Trigger / Trigger / Déclenchement
2) Helligkeit / brightness / Luminosité 4) 8 mm tief / 8 mm deep / 8 mm de profondeur

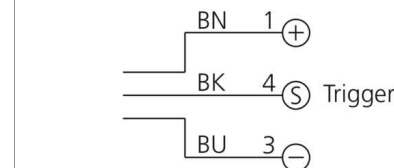

BK : schwarz / black / noir
BN : braun / brown / marron BU : blau / blue / bleu

Technische Daten	Technical data	Caractéristiques techniques	+20°C, 24 V DC
Lichtfarbe	Light color	Couleur de lumière	Infrarot / Infrared / Infrarouge
Betriebsspannung	Service voltage	Tension de service	18 ... 35 V DC (Supply Class 2)
Leerlaufstrom (max.)	No-load current (max.)	Courant de marche à vide (max.)	370 mA (24 V DC)
Leistung	Power	Puissance	8,9 W / 24 V DC
Umgebungstemperatur Betrieb	Ambient temperature during operation	Température ambiante de fonctionnement	0 ... +40 °C
Schutzart	Protection type	Indice de protection	IP 67
Risikogruppe (DIN EN 62471)	Risk group (DIN EN 62471)	Groupe de risque (DIN EN 62471)	Freie Gruppe / Free group / Groupe libre

Stand 19.06.21, Änderungen vorbehalten
As of 06/19/21, subject to change
État 19.06.21, sous réserve de modifications

 Enclosure Type 1 Supply Class 2
NFPA 79 Applications only. For adapters providing field wiring means refer to product information or customer support.



Sicherheitshinweise
 **Allgemeiner Sicherheitshinweis**
WARNUNG! Kein Sicherheitsbauteil gemäß 2006/42/EG und EN 61496-1 /-2! Darf nicht zum Personenschutz eingesetzt werden! Nichtbeachtung kann zu Tod oder schwersten Verletzungen führen! Nur bestimmungsgemäß verwenden!

Safety instructions
 **General safety notice**
WARNING! Not a safety component pursuant to 2006/42/EG and EN 61496-1/-2! May not be used for personal protection! Non-compliance can lead to death or serious injuries! Only use as directed!

Consignes de sécurité
 **Consigne de sécurité générale**
AVERTISSEMENT ! Ce produit n'est pas un composant de sécurité au sens des réglementations 2006/42/CE et NF EN 61496-1/-2 ! Ne pas l'utiliser pour la protection des personnes ! Le non-respect de cette consigne peut entraîner la mort ou des blessures graves ! N'utiliser le produit que selon son utilisation conforme !

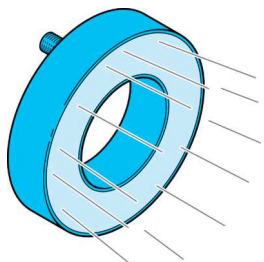

di-soric GmbH & Co. KG
 Steinbeisstraße 6
 DE-73660 Urbach
 Germany
 Tel: +49 (0) 7181/9879-0
 info@di-soric.de · www.di-soric.com

206466

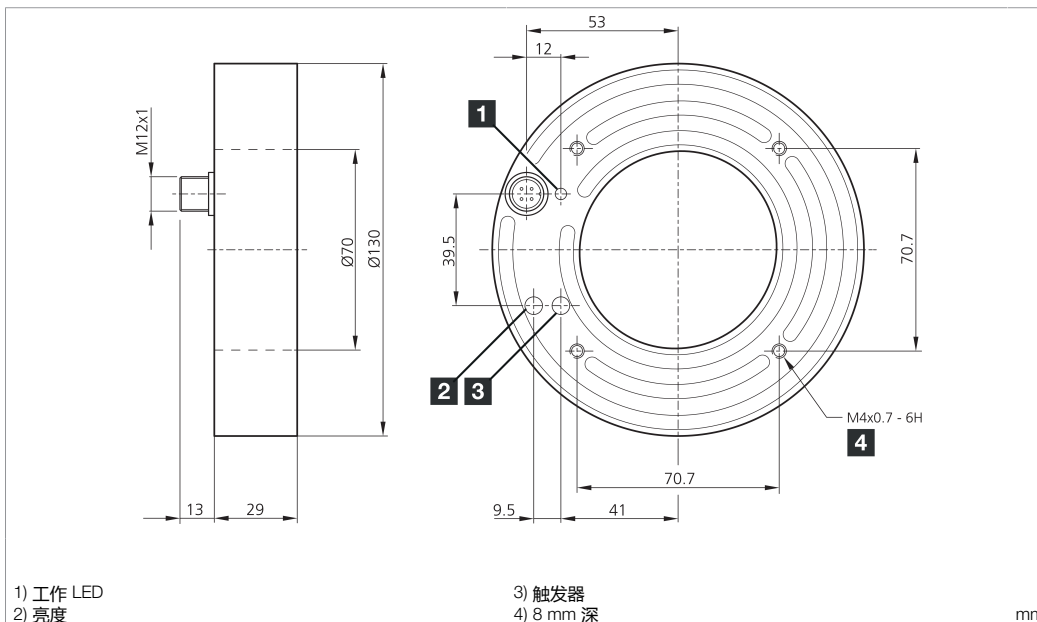

1) 工作 LED
 2) 亮度

3) 触发器
 4) 8 mm 深

mm

BK : 黑色
 BN : 棕色

BU : 蓝色

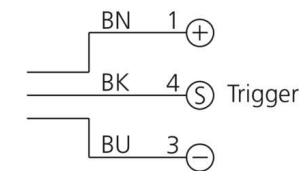

技术数据

光色

工作电压

空载电流 (最大)

功率

工作环境温度

防护等级

风险组 (DIN EN 62471)

+20°C, 24 V DC

红外

18 ... 35 V DC (Supply Class 2)

370 mA (24 V DC)

8,9 W / 24 V DC

0 ... +40 °C

IP 67

无危险类

版本 21.06.19, 保留变更权



Enclosure Type 1 Supply Class 2
 NFPA 79 Applications only. For ad-
 apters providing field wiring me-
 ans refer to product information or
 customer support.



安全提示



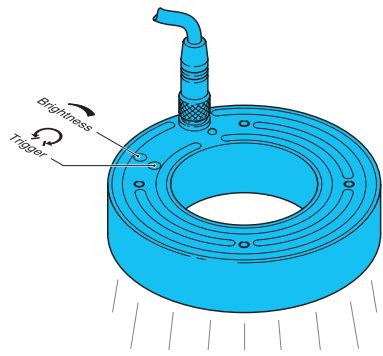

一般安全提示

警告！没有符合 2006/42/EU 和 EN 61496-1 /-2 标准的安全结构件！不得用于人身安全保护！不遵守规定会导致死亡或重伤危险！仅按规定使用！



Ringbeleuchtung

-  Nicht dauerhaft in den Lichtstrahl blicken!

-  Diese Beleuchtung erzeugt eine sichtbare oder unsichtbare Strahlung, welche bei dauerhafter Einwirkung schädlich sein kann!

-  Wärmekonvektion gewährleisten!

Die Erwärmung der Beleuchtung hat einen direkten Einfluss auf die Alterung/Lebensdauer der Beleuchtungs-LEDs! Je höher die Temperatur, desto stärker die Alterung.

-  - Beleuchtung nicht abdecken

 - Beleuchtungsintensität an die Applikation anpassen (überschüssige Lichtstärke vermeiden)
 - Dauerlicht reduzieren/vermeiden (Triggerfunktion nutzen)
 - Beleuchtung bei längerer Nichtnutzung abschalten

-  Betriebswärme folgendermaßen abführen:

 - Montage an eine kühlende Fläche (Maschinenkörper)
 - Montage an einen externen Kühlkörper

-  Regelmäßige Reinigung!

Starke Verschmutzung verhindert den Lichtaustritt und erhöht die Wärmeentwicklung.

Ringlight

-  Do not look into the light beam for a prolonged period of time!

-  This light produces radiation which may or may not be visible and prolonged exposure may be harmful!

-  Ensure heat convection!

The heating of the light has a direct impact on the ageing/lifetime of the light LEDs! The higher the temperature, the faster the ageing process.

-  - Do not cover the light

 - Adapt the light intensity to the application (avoid excessive light intensity)
 - Reduce/avoid continuous light (use trigger function)
 - Switch off light when it is not being used for longer periods of time

-  Dissipate operating heat as follows:

 - Install on a cool surface (machine structure)
 - Install on an external cooling element

-  Clean on a regular basis!

Heavy contamination prevents light emission and increases heat development.

Anneau lumineux

-  Ne pas regarder le rayon lumineux pendant une période de temps prolongée!

-  Cette lumière produit des radiations qui pourraient ou ne pourraient pas être visibles et une exposition prolongée peut être nuisible!

-  Protéger de l'émission de chaleur!

La chaleur émise par la lumière a un effet direct sur le vieillissement/la durée de vie des LED! Plus la température s'élève, plus rapide est le processus de vieillissement.

-  - Ne pas couvrir la lumière

 - Adapter l'intensité lumineuse en fonction de la nécessité de l'application (éviter l'excès d'intensité lumineuse)
 - Réduire/éviter l'éclairage continu (utiliser la fonction de déclenchement)
 - Éteindre l'éclairage lorsqu'il n'est pas utilisé pendant de longues périodes

-  Dissiper la chaleur d'émission comme suit:

 - Installer sur une surface froide (structure de la machine)
 - Installer sur un élément refroidissant externe

-  Nettoyer régulièrement

L'encrassement entrave la bonne émission de l'éclairage et accroît l'émission de chaleur.