

SH-GLA-10-10-30

Gelenkarm
Articulated arm
Bras articulé

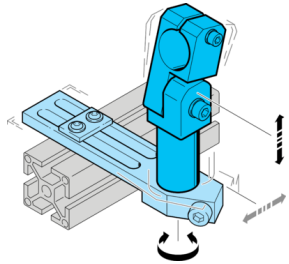

di-soric GmbH & Co. KG
Steinbeisstraße 6
DE-73660 Urbach
Germany
Tel: +49 (0) 7181/9879-0
info@di-soric.de · www.di-soric.com

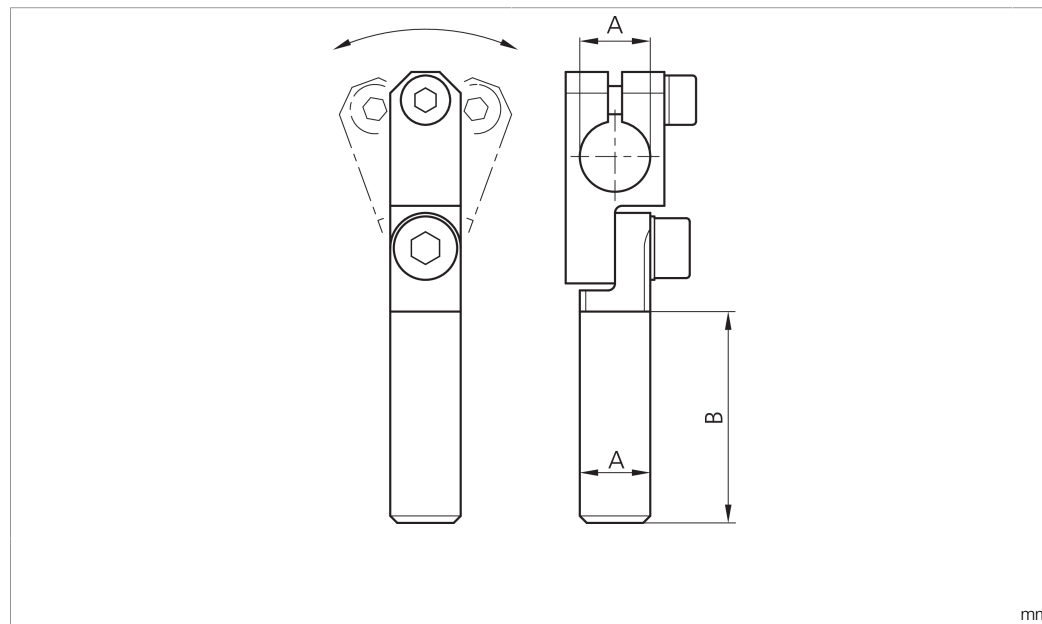

Technische Daten	Technical data	Caractéristiques techniques	
Produktserie	Product series	Gamme de produits	Z-UBT-KL-MS Montagesystem / Z-UBT-KL-MS Assembly system / Système de montage Z-UBT-KL-MS
Geeignet für	To be used for	Convient pour	Klemmbolzen 10 mm / Clamping pin 10 mm / Boulon de serrage 10 mm
Durchmesser A	Diameter A	Diamètre A	10 mm
Maß B	Dimension B	Dimension B	30 mm
Besonderheiten	Characteristics	Particularités	Justierbar / Adjustable / Réglable
Material	Material	Matériau	Metall / Metal / Métal

Stand 10.09.21, Änderungen vorbehalten
As of 09/10/21, subject to change
État 10.09.21, sous réserve de modifications

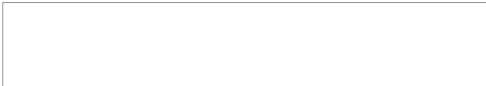

SH-GLA-10-10-30

Articulated arm

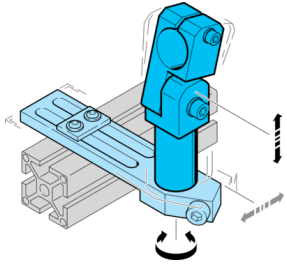

di-soric GmbH & Co. KG
 Steinbeisstraße 6
 DE-73660 Urbach
 Germany
 Tel: +49 (0) 7181/9879-0
 info@di-soric.de · www.di-soric.com

203901

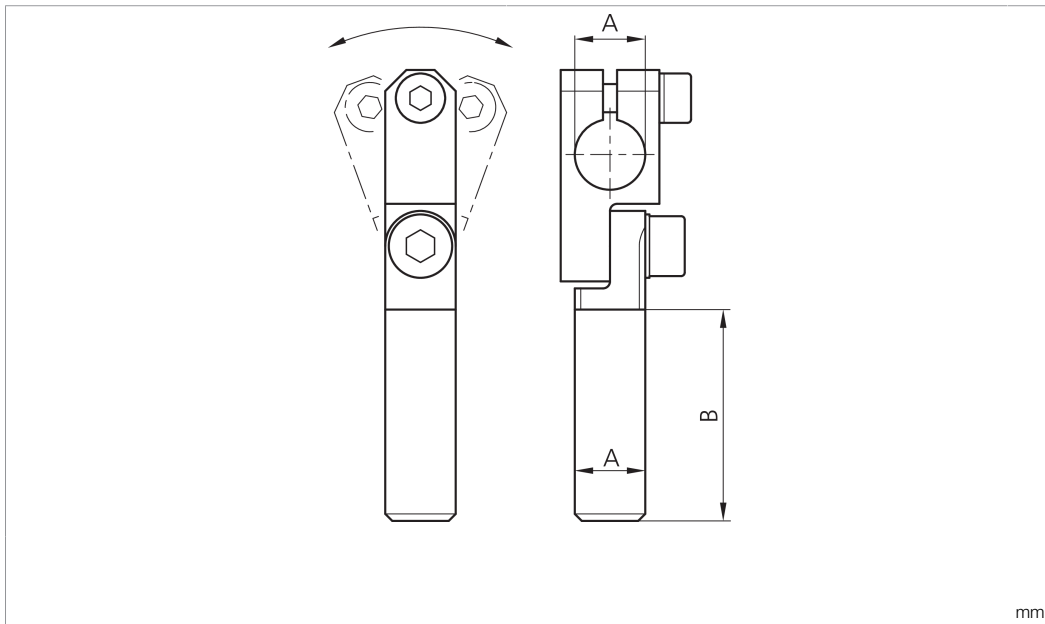

技术数据

产品系列

Z-UBT-KL-MS 安装系统

适合用于

夹紧螺栓 10 mm

直径 A

10 mm

尺寸 B

30 mm

特点

可校准

材料

金属

版本 21.09.10, 保留变更权