

SH-WKA-10-10-60

Winkelarm
Angle arm
Bras d'équerrage

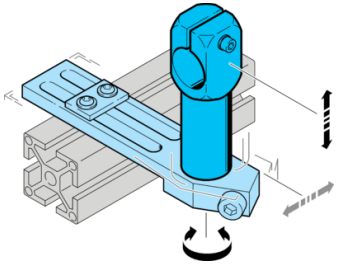

di-soric GmbH & Co. KG
Steinbeisstraße 6
DE-73660 Urbach
Germany
Tel: +49 (0) 7181/9879-0
info@di-soric.de · www.di-soric.com

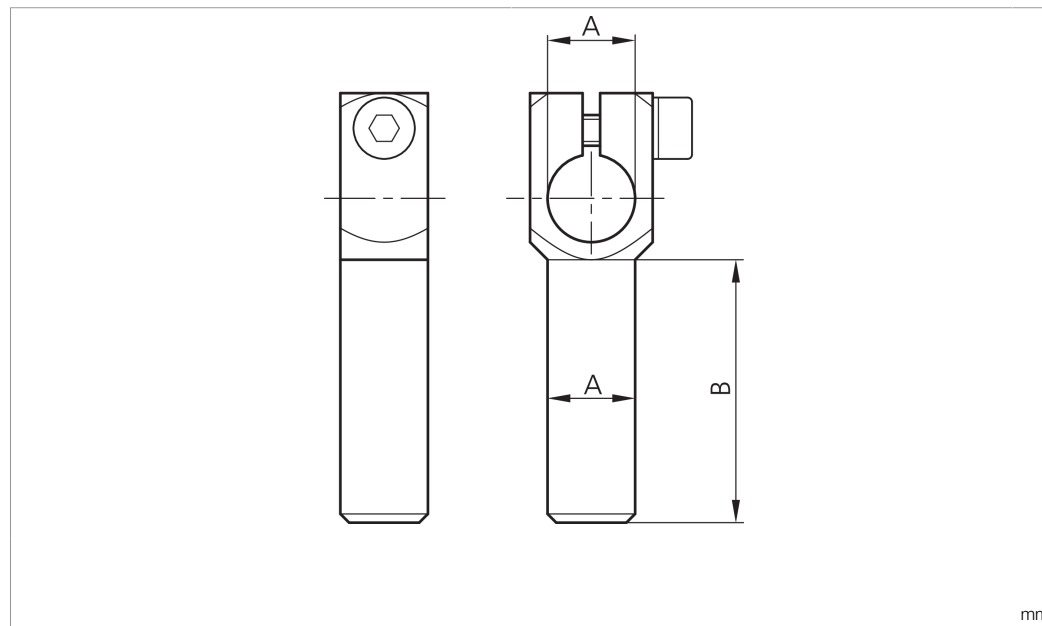

Technische Daten	Technical data	Caractéristiques techniques	
Produktserie	Product series	Gamme de produits	Z-UBT-KL-MS Montagesystem / Z-UBT-KL-MS Assembly system / Système de montage Z-UBT-KL-MS
Geeignet für	To be used for	Convient pour	Klemmbolzen 10 mm / Clamping pin 10 mm / Boulon de serrage 10 mm
Durchmesser A	Diameter A	Diamètre A	10 mm
Maß B	Dimension B	Dimension B	60 mm
Material	Material	Matériau	Metall / Metal / Métal

Stand 10.09.21, Änderungen vorbehalten
As of 09/10/21, subject to change
État 10.09.21, sous réserve de modifications

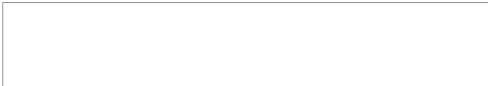

SH-WKA-10-10-60

Angle arm

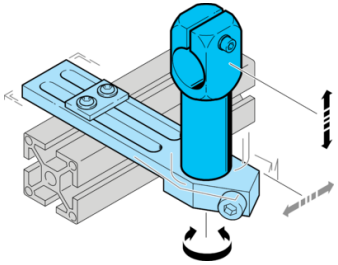

di-soric GmbH & Co. KG
 Steinbeisstraße 6
 DE-73660 Urbach
 Germany
 Tel: +49 (0) 7181/9879-0
 info@di-soric.de · www.di-soric.com

203893

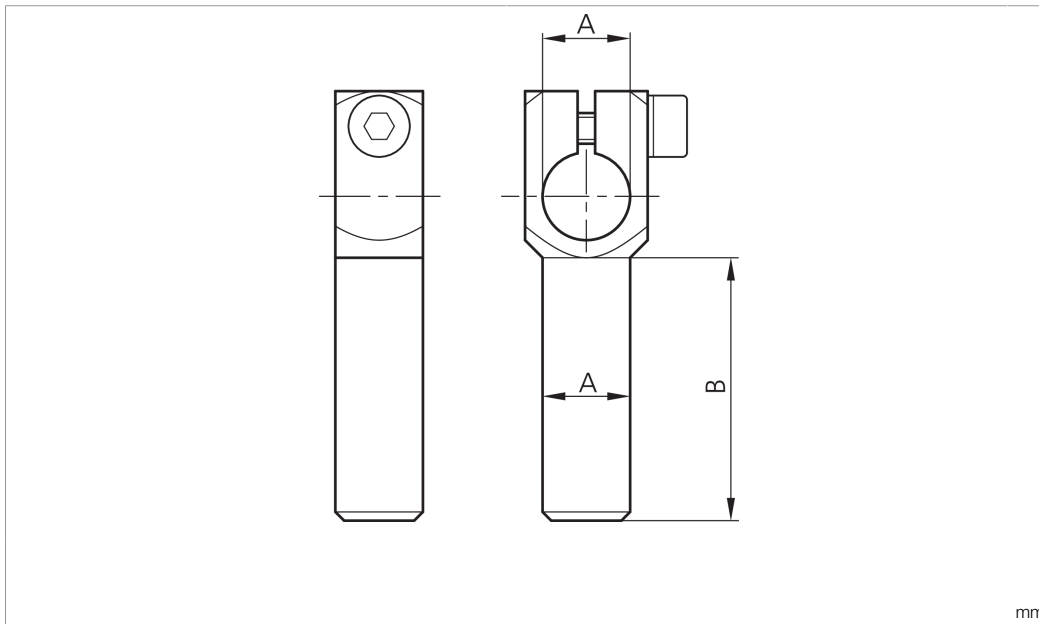

技术数据

产品系列

Z-UBT-KL-MS 安装系统

适合用于

夹紧螺栓 10 mm

直径 A

10 mm

尺寸 B

60 mm

材料

金属

版本 21.09.10, 保留变更权