

SH-4-10

Sensorhalter Ø 4mm
 Sensor holder Ø 4mm
 Support de détecteur Ø 4 mm

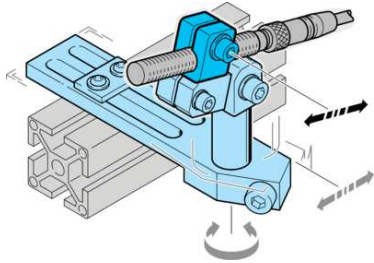

di-soric GmbH & Co. KG
 Steinbeisstraße 6
 DE-73660 Urbach
 Germany
 Tel: +49 (0) 7181/9879-0
 info@di-soric.de · www.di-soric.com

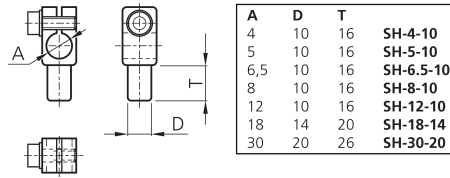

mm

Technische Daten	Technical data	Caractéristiques techniques	+20°C, 24 V DC
Produktserie	Product series	Gamme de produits	Z-UBT-KL-PH Produkthalterung / Z-UBT-KL-PH Product bracket / Support de produit Z-UBT-KL-PH
Durchmesser A	Diameter A	Diamètre A	4 mm
Abstandsmaß D	Distance dimension D	Mesure de distance D	10 mm
Geeignet für	To be used for	Convient pour	Klemmbolzen 10 mm / Clamping pin 10 mm / Boulon de serrage 10 mm
Material	Material	Matériau	Kunststoff / Plastic / Plastique

Stand 22.09.21, Änderungen vorbehalten
 As of 09/22/21, subject to change
 État 22.09.21, sous réserve de modifications



SH-4-10

传感器支座 Ø 4mm

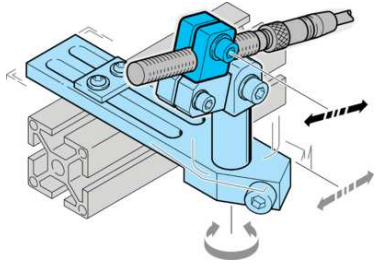

di-soric GmbH & Co. KG
 Steinbeisstraße 6
 DE-73660 Urbach
 Germany
 Tel: +49 (0) 7181/9879-0
 info@di-soric.de · www.di-soric.com

203913

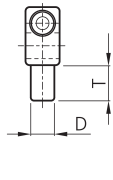
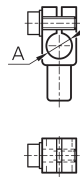

A	D	T	
4	10	16	SH-4-10
5	10	16	SH-5-10
6,5	10	16	SH-6.5-10
8	10	16	SH-8-10
12	10	16	SH-12-10
18	14	20	SH-18-14
30	20	26	SH-30-20

mm

技术数据

产品系列

直径 A

距离尺寸 D

适用于

材料

+20°C, 24 V DC

Z-UBT-KL-PH 产品支架

4 mm

10 mm

夹紧螺栓 10 mm

塑料

版本 21.09.22, 保留变更权

Systemhalter Serie HS

Grundhalter Ø 12 mm

System holder series HS

Basic system holder Ø 12 mm

Systèmes de fixation Série HS

12 mm du support Ø de système de base

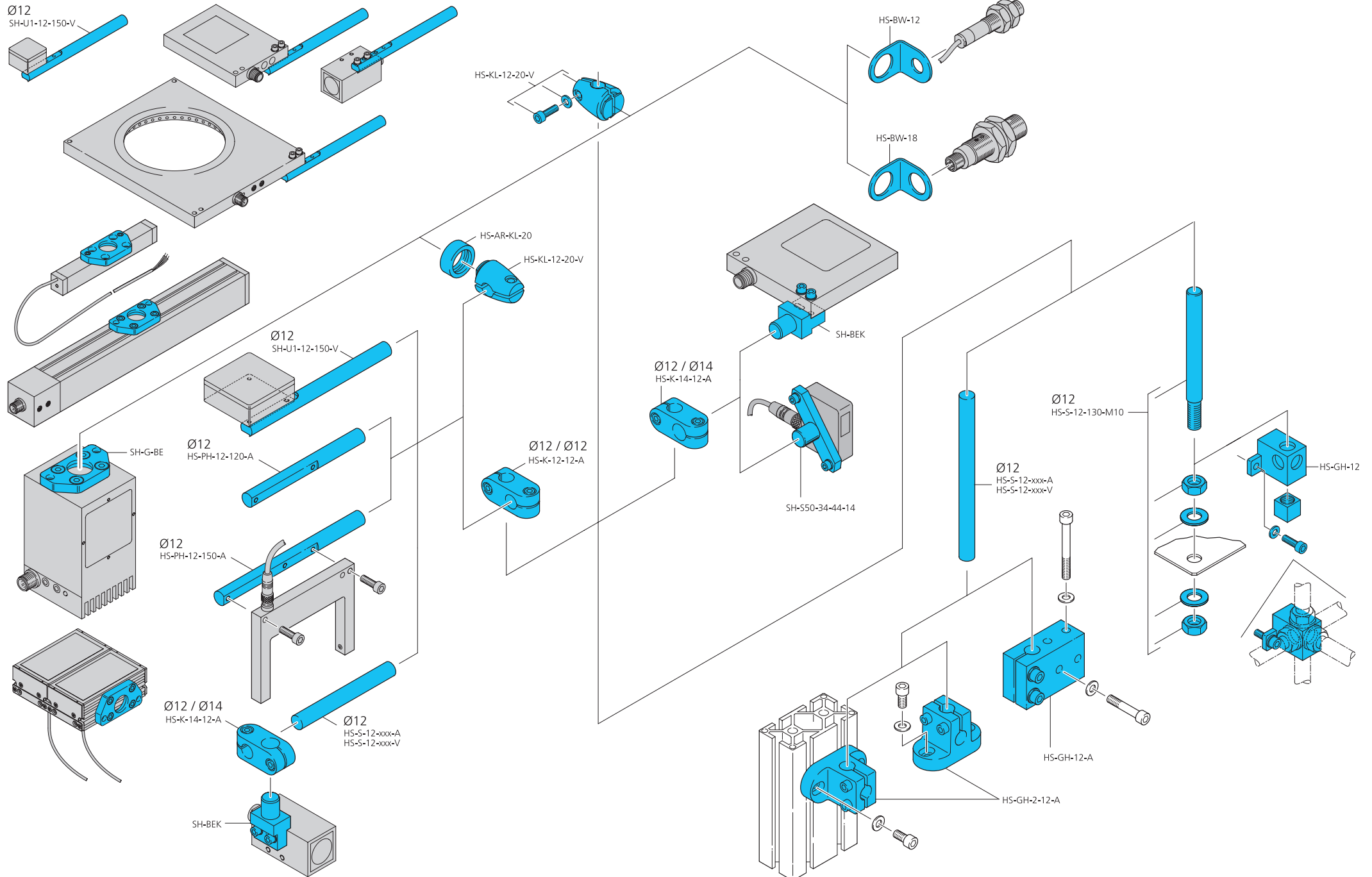

Systemhalter Serie HS

Grundhalter Ø15 mm

System holder series HS

Basic system holder Ø15 mm

Systèmes de fixation Série HS

15 mm du support Ø de système de base

