

# SH-WSL-L-10-40-U

Winkelklemmstück  
 Angle clamp  
 Élément de fixation d'angle

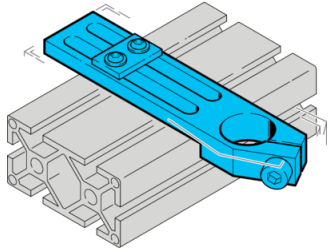

di-soric GmbH & Co. KG  
 Steinbeisstraße 6  
 DE-73660 Urbach  
 Germany  
 Tel: +49 (0) 7181/9879-0  
 info@di-soric.de · www.di-soric.com

203886

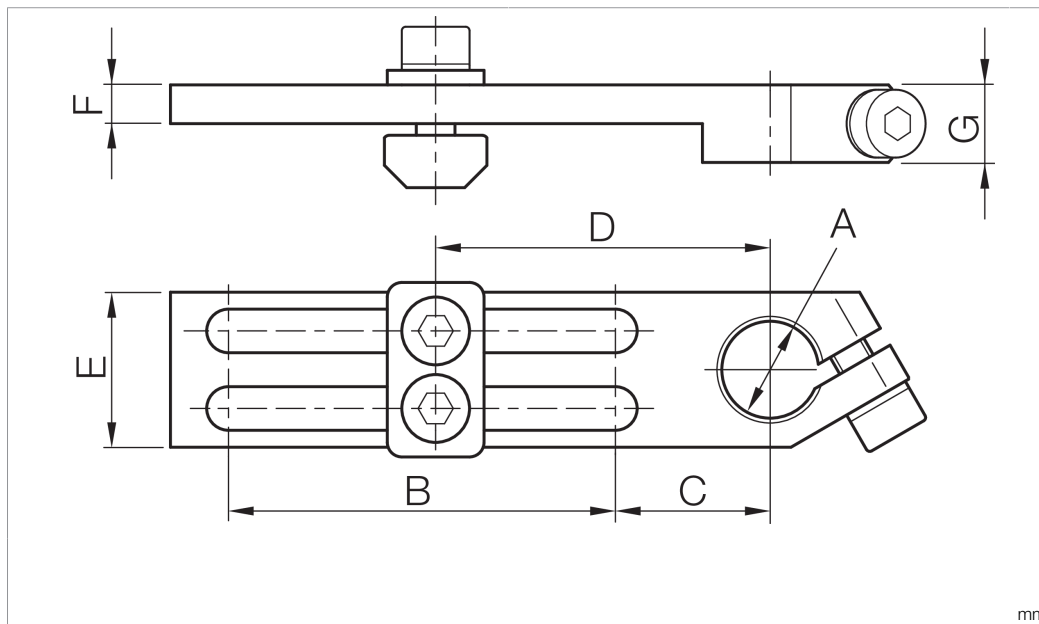

mm

Technische Daten	Technical data	Caractéristiques techniques	
Produktserie	Product series	Gamme de produits	Z-UBT-KL-MS Montagesystem / Z-UBT-KL-MS Assembly system / Système de montage Z-UBT-KL-MS
Geeignet für	To be used for	Convient pour	Klemmbolzen 10 mm / Clamping pin 10 mm / Boulon de serrage 10 mm
Durchmesser A	Diameter A	Diamètre A	10 mm
Maß B	Dimension B	Dimension B	40 mm
Abstandsmaß C	Distance dimension C	Mesure de distance C	16 mm
Abstandsmaß D	Distance dimension D	Mesure de distance D	36 mm
Abstandsmaß E	Distance dimension E	Mesure de distance E	16 mm
Abstandsmaß F	Distance dimension F	Mesure de distance F	4 mm
Abstandsmaß G	Distance dimension G	Mesure de distance G	8 mm
Material	Material	Matériau	Metall / Metal / Métal

Stand 10.09.21, Änderungen vorbehalten  
 As of 09/10/21, subject to change  
 État 10.09.21, sous réserve de modifications



**SH-WSL-L-10-40-U**

Angle clamp

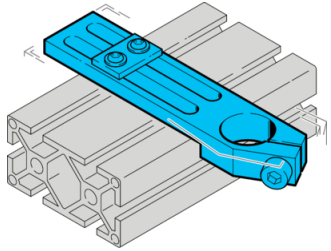

di-soric GmbH & Co. KG  
 Steinbeisstraße 6  
 DE-73660 Urbach  
 Germany  
 Tel: +49 (0) 7181/9879-0  
 info@di-soric.de · www.di-soric.com

203886

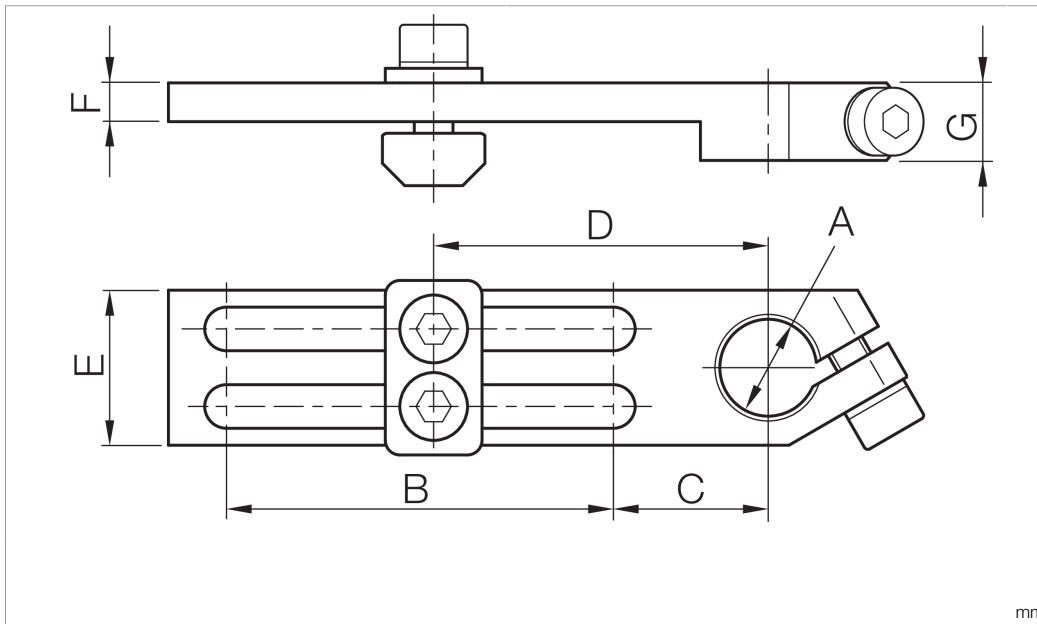

mm

**技术数据**

产品系列	Z-UBT-KL-MS 安装系统
适合用于	夹紧螺栓 10 mm
直径 A	10 mm
尺寸 B	40 mm
距离尺寸 C	16 mm
距离尺寸 D	36 mm
距离尺寸 E	16 mm
距离尺寸 F	4 mm
距离尺寸 G	8 mm
材料	金属

版本 21.09.10, 保留变更权