

D-Sub Steckverbinder, Lötkelche, gestanzte Kontakte D-Sub Connectors, Solder Cups, Stamped Contacts

Technische Daten / Technical Data

Gehäuse	Stahl vernickelt, verzinkt
Shell	Steel, tin coated over nickel
Isolierkörper	Thermoplast, nach UL94 V-0
Insulator	Thermoplastic, rated UL94 V-0
Kontaktmaterial	Kupferlegierung
Contact Material	Copper alloy
Kontaktoberfläche	Gold über Nickel
Contact Surface	Gold over nickel
Durchgangswiderstand	< 20 mΩ
Contact Resistance	< 20 mΩ
Isolationswiderstand	> 1000 MΩ
Insulation Resistance	> 1000 MΩ
Spannungsfestigkeit	1 kV AC
Test Voltage	1 kV AC
Nennstrom	1 A
Current Rating	1 A
Temperaturbereich	-55 °C ... +125 °C
Temperature Range	-55 °C ... +125 °C

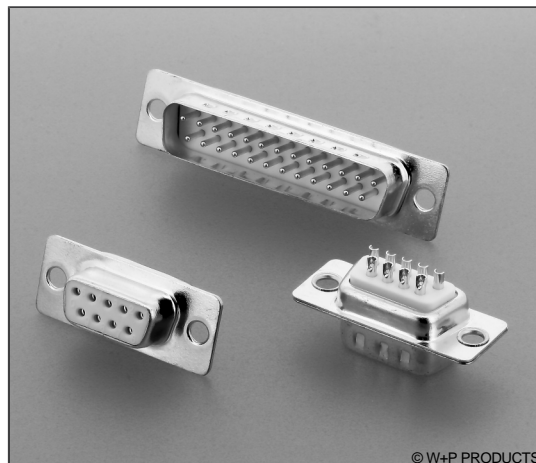

© W+P PRODUCTS

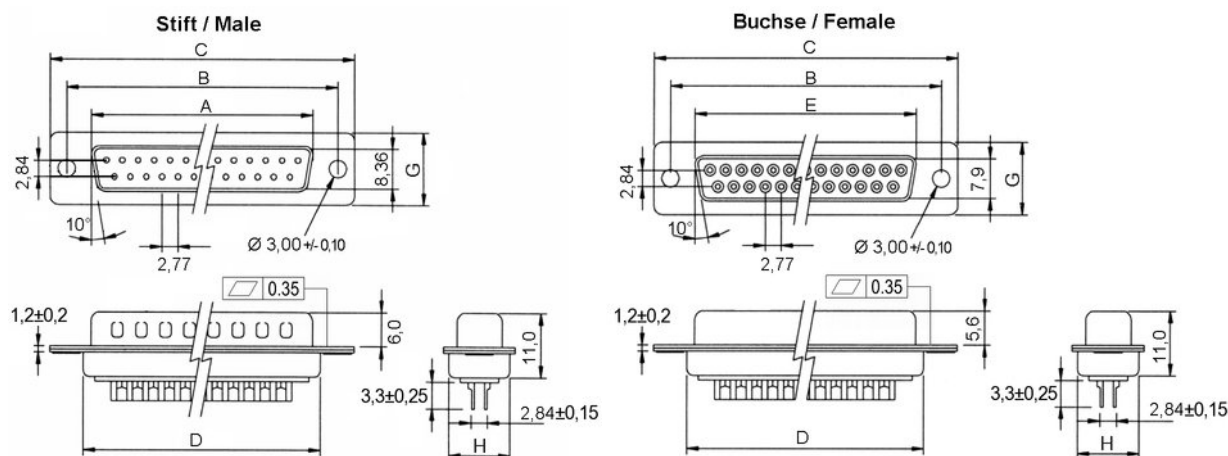

n	A	B	C	D	E	G	H
09	16,92	24,99	30,81	19,28	16,33	12,55	10,72
15	25,25	33,62	39,14	27,51	24,66	12,55	10,72
25	38,96	47,04	53,04	41,30	38,38	12,55	10,72
37	55,42	63,50	69,32	57,71	54,84	12,55	10,72
50	52,86	61,11	66,90	55,30	52,34	15,20	13,40

Series	Contacts*	Terminal*	Quality	Mounting*
105	09	1	3	3
105 Gestanzte Kontakte Stamped contacts	09/15/25/37/50	1 Stift Male 2 Buchse Female	GK 3 >50 Steckzyklen Quality class 3: 50 cycles min.	0 ... CL Lt. Tech. Info. See Tech. Info.

* Dies ist ein **Bestellbeispiel** -
bitte durch Ihre Spezifikationen ersetzen.
* This is an **order example** -
please replace by your specifications.

Durchgangsloch / Through Hole

0 Durchgangsloch 3,05mm
3.05mm Through Hole

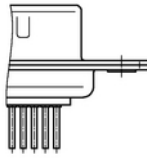

Gewindeniet vorn / Thread Rivet Front

B1 Gewindeniet UNC 4-40
UNC 4-40 Thread Rivet
B2 Gewindeniet M3
M3 Thread Rivet

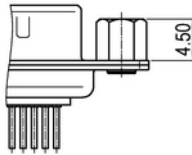

Gewindeniet hinten / Thread Rivet Back

1 Gewindeniet UNC 4-40
UNC 4-40 Thread Rivet
2 Gewindeniet M3
M3 Thread Rivet

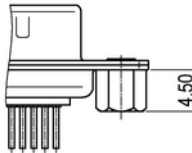

Gewindebolzen vorn / Thread Bolt Front

3 Gewindebolzen UNC 4-40
UNC 4-40 Thread Bolt
4 Gewindebolzen M3
M3 Thread Bolt

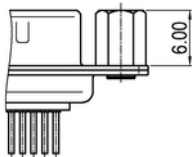

Gewindebolzen hinten / Thread Bolt Back

5 Gewindebolzen UNC 4-40
UNC 4-40 Thread Bolt
6 Gewindebolzen M3
M3 Thread Bolt

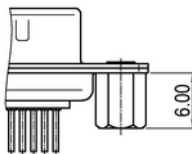

Board Lock

BL Board Lock mit UNC 4-40 Gewinde
Board Lock with UNC 4-40 Thread

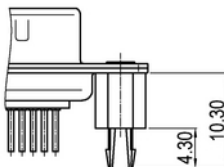

Combi-Lock

CL Combi-Lock mit UNC 4-40 Gewinde
Combi Lock with UNC 4-40 Thread

