



ESSENTRA

essentracomponents.com

© 2013 Essentra Components. All rights reserved.
 Registered in England, Company No. 547495.
 Registered Office: Avebury House,
 201-249 Avebury Boulevard, Milton Keynes, MK9 1AU

Condition of Sale can be found on our website:
 essentra.com.

Essentra Components does not warrant that the files will be error free and may create new versions ("Upgrades") at any time, which may correct such errors. Essentra Components has no obligation to notify you of such upgrades. Any upgraded file will be published to the website, when it becomes available.

You are not permitted to load any of the files on to a network server for the purposes of distribution to one or more other computer(s) on that network or to effect such distribution. Essentra Components shall not be liable for any loss or damage whatsoever or however caused, arising directly or indirectly from the use of the files.

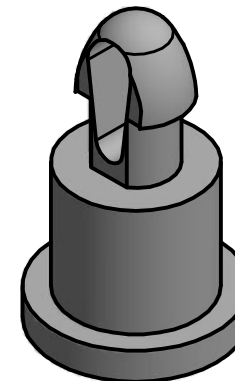
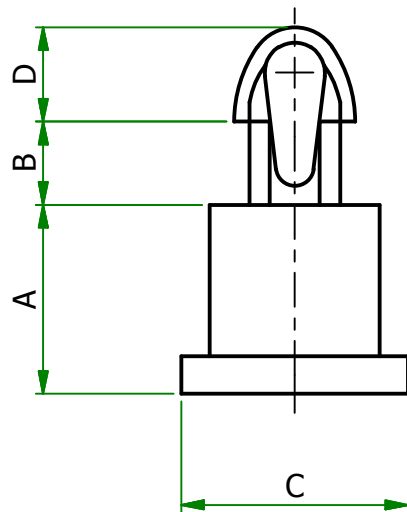
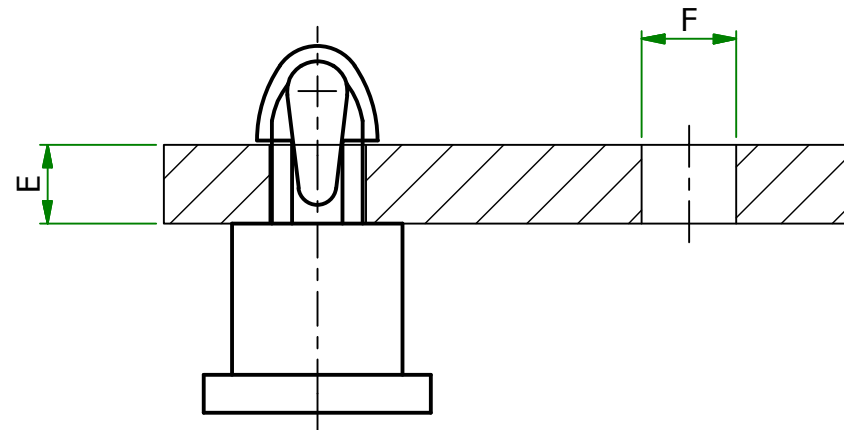
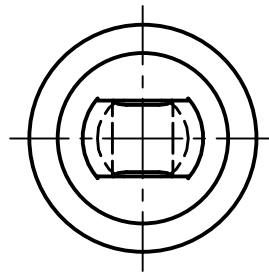

| Part Number | A | B | C | D | E | F | Part ID |
|--------------|-----|-----|-----|-----|-----|-----|---------|
| 100630400002 | 2.8 | 2.0 | 5.0 | 2.5 | 1.6 | 2.5 | 1070118 |

UNLESS OTHERWISE STATED

| ALL DIMENSIONS IN mm | | | | DO NOT SCALE | |
|----------------------|------|-------|--------|---|--|
| LINEAR TOLERANCE | | | | THIRD ANGLE PROJECTION | |
| SIZE | (0) | (0.0) | (0.00) | ANGULAR TOLERANCE ±0.5 DEGREES UNSPECIFIED RADII 0.25mm DRAFT ANGLE 0.5 DEGREES DIMENSIONS IN BRACKETS [] ARE IN INCHES FOR REFERENCE ONLY | |
| 0-10mm | ±0.5 | ±0.15 | ±0.10 | | |
| 10-30mm | ±0.5 | ±0.20 | ±0.15 | | |
| 30-50mm | ±0.5 | ±0.30 | ±0.20 | | |
| 50-100mm | ±0.8 | ±0.50 | ±0.25 | | |
| 100-200mm | ±1.5 | ±0.80 | ±0.40 | | |
| 200-300mm | ±2.0 | ±1.20 | ±0.80 | | |
| 300-500mm | ±3.0 | ±2.00 | ±1.00 | CREATE DATE: 30/Aug/2016 | |
| +500mm | ±5.0 | ±3.00 | ±1.50 | | |

ORG.SCALE NTS

MATERIAL NYLON (NATURAL)

ITEM No. 100630400002

TITLE SNAP-FIT SUPPORT SPACER

DWG.No. P160271-2

ISSUE No. 1

UNCONTROLLED