



MIS432C22Q5H285

Int.Step 12-72VDC, RS485, EncC-L

ServoStep MIS is a series of integrated stepper motors with servo control (closed-loop) and up to 3000 RPM.

It consists of NEMA 17..23..34..43 size motors with holding torques from 0.36 Nm up to 25 Nm. All motors are programmable and have 8 I/O points (each can be DI or DO or AI).

Options include:

- incremental (semi-absolute) encoder*). absolute multiturn encoder
- brake module*)
- radial or axial*) connectors
- CANopen
- Ethernet interface w/built-in switch for easy daisy-chaining and all protocols (Profinet. EtherNet/IP. EtherCAT. Sercos. ModbusTCP/UDP. Powerlink).
- Wireless versions are also possible: WLAN or BlueTooth.
- Special shaft versions include double shaft and hollow shaft. contact JVL to learn which combinations are possible.
- Higher IP versions are also available. *) Depending of other options



General information



Description	Int.Step 12-72VDC, RS485, EncC-L, 4xM12. 17pF:8xDIO/AI+RS422+RS485 8pF:RS485 5pF:485, High Resolution: 409.600 step/rev. ±0.01 RPM, Programmable (incl. current, position & velocity), Closed-Loop Semi-Abs. Encoder 4096 CPR, ø19x55.4 w/ 6x6 Key, Shaft: IP42, Motor: IP42, 110x247 mm Holding Torque: 25.0 Nm Max. 500 W Radial Connector 12-72VDC Mechanical Power: 245 W		
Manufacture	JVL	Motor type	Integrated Stepper - Rotating
Motor resolution	409600	Encoder type	H2 Incremental/abs_singleturn
Integrated PLC	Yes	PLC no. of DI/DO/AI	8
Closed loop	Yes	STO connector	No
Integrated gear	No	Gear ratio	
Brake	No	Speed [Rpm]	1500.00
Connectivity: Without module	RS485	Power Peak [W]	245.35
Flange Type Front		Protection House/Shaft	
Shaft size - Front [mm]	19.0 mm		
Running torque [Nm]	25.0	Rated Winding current [A]	9.0
Main supply [V]	12-72	Voltage type - Main	DC



MIS432C22Q5H285

Int.Step 12-72VDC, RS485, EncC-L

General information

Control voltage (CVI/O+) [VDC]	7-28	Holding torque [Nm]	25.0
Shaft Double	No		
Weight net [kg]	11.16	MTBF 100% [Year]	13
Weight gross [kg]	11.34	MTBF 30% [Year]	15
Software	MacTalk		
CE Marked	Yes		
			
Approval - ROHS-3	Yes		
			
Approval UL	No		
Tariff no	85015100	Country Of Origin	DK



MIS432C22Q5H285

Int.Step 12-72VDC, RS485, EncC-L

Mechanical information

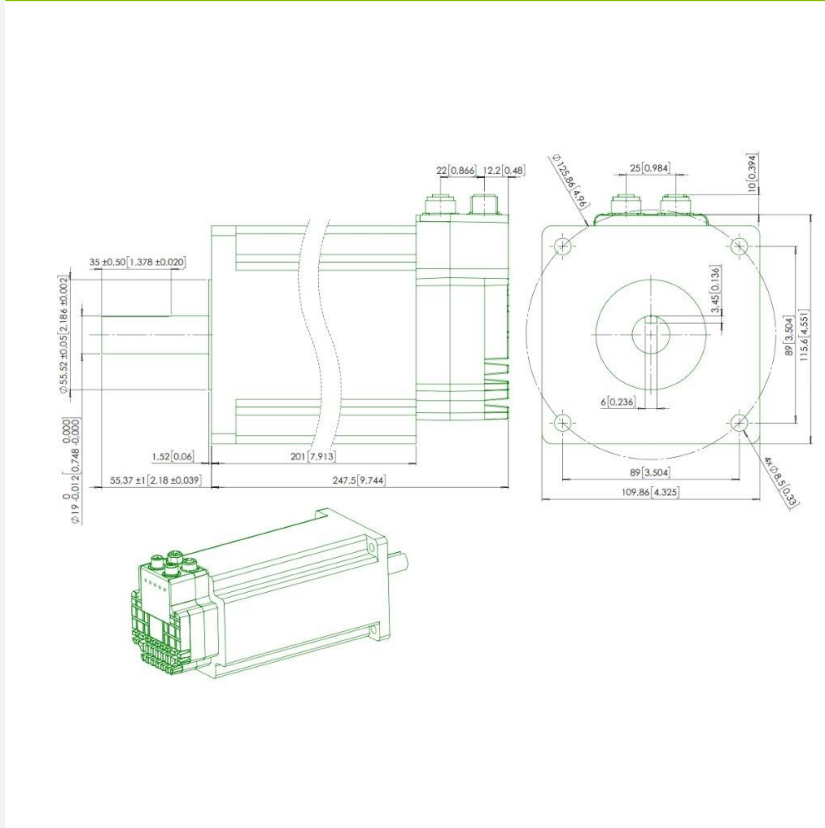

Motor length [mm]	247.0	Motor width [mm]	110.0
Motor height [mm]	127.5		
Protection house	IP42	Protection shaft	IP42
		Flange Rear	No
Flange Type Front		Flange Type Rear	
Motor diameter center front [mm]		Motor diameter center rear [mm]	
Bolt circle diameter front [mm]		Bolt circle diameter front [mm]	
Mounting holes front [mm]	8.5 mm	Mounting holes rear [mm]	
Flange material	Aluminium	Flange Thickness [mm]	
		Shaft Double	No
Shaft Type Output	Key	Shaft Type Rear	
Shaft size - Front [mm]	19.0 mm	Shaft size - Rear	-
Shaft length Front [mm]	55.4	Shaft length Rear [mm]	
Shaft material	Stainless steel AISI303		
Shaft Key included	Key mounted in shaft	Shaft Key Dimension	6x6x35 Rnd-Sqr
Front bearing type		Rear bearing type	
Radial load [N]	13650	Radial load distance [mm]	20



MIS432C22Q5H285

Int.Step 12-72VDC, RS485, EncC-L

Mechanical information

Axial load [N]	3135		
Axial play [mm]		Axial play force [N]	
Integrated gear	No	Gear ratio	
Gear efficiency [%]	-	Gear backlash [ArcMin]	-
Brake	No	Brake - Go ON time [ms]	-
Brake Holding torque [Nm]	-	Brake - Go OFF time [ms]	-
Rotor inertia [kgcm²]	16.2	Max inertia factor	40
Precision Motor - Absolute [Deg]	0.35	Precision Motor - Max Load [Deg]	
Precision Motor - Repeatability [Deg]	0.15	Step angle [°/full step]	1.8°
2D [PDF]	No	2D [DWG]	No
3D [DWG]	No	3D [EASM]	No
3D [IGES]	No	3D [STEP]	No
Datasheet - pdf		CAD file page	Link
User Manual	Download	WEB page	Link
Approval UL	No	STO connector	No
Approval - ATEX	No	Approval TÜV - STO	No
Oil resistant			
Temperature ambient [°C]	0...40 °C and 0...70 °C with derating of performance		
Temperature storage	-40...70 °C		
Humidity working	5...93% non-condensing		
Vibration	5-25 Hz: +/-1.6mm, 25-500Hz: 4G, 1.0 oct./min		
Shock	15G, 30ms. 6 x 1000 cycles in +/-X, +/-Y, +/-Z		
Withstand Voltage	500 VDC between earth and supply ground		
EMC in general	EMC Directive DIR2014/30/EU		
EMC Emission	EN61800-3 / EN61000-6-3 / EN61000-6-4 all 2. environment		
EMC Immunity	En IEC 61800-3 / EN61000-6-1 all 2. environment		
Safety in general	LVD DIR2014/35/EU / EL61800 - USA and Canada only MIS34x products are pending		
Safety wo STO	EN60950-1		
Safety w STO	EN60950-1 / EN61508-1/-2 SIL3 / ISO13849-1/-2 / ISO62061 / EN61800-5-1/-2		
Inviromental	IEC 60068-2-27, Test Ea. Shock test		
	IEC 60068-2-6, Test Fc. Vibration test		
	IEC 60068-2-2, Test Bd. covers temperaturerise/dry heat		
	IEC 60068-2-78, Perm. moisture/Damp heat, steady state		
REACH SVHC document			
Low voltage Directive			
No Dual Use			



MIS432C22Q5H285

Int.Step 12-72VDC, RS485, EncC-L

Mechanical information

Duty Cycle		Max Duty Cycle [%]	
Axial Load Typical [N]	3135	Axial Load Long [N]	1109

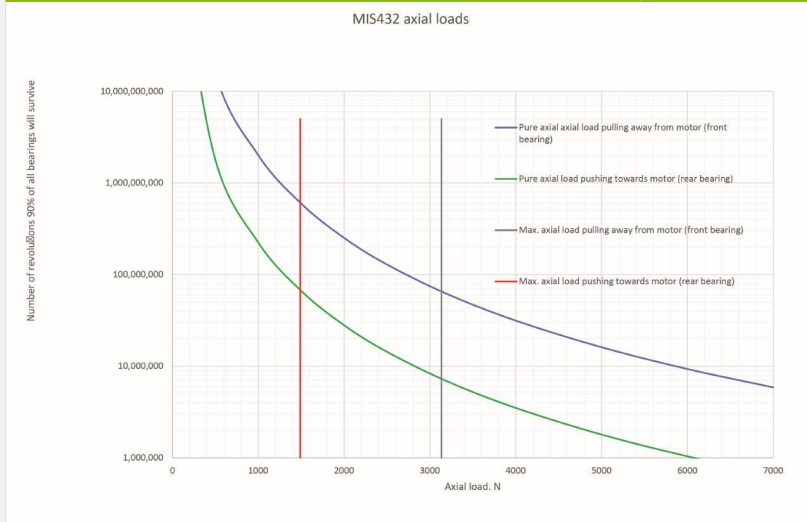

Radial Load Typical [N]	5921	Radial Load Long [N]	1208
--------------------------------	------	-----------------------------	------

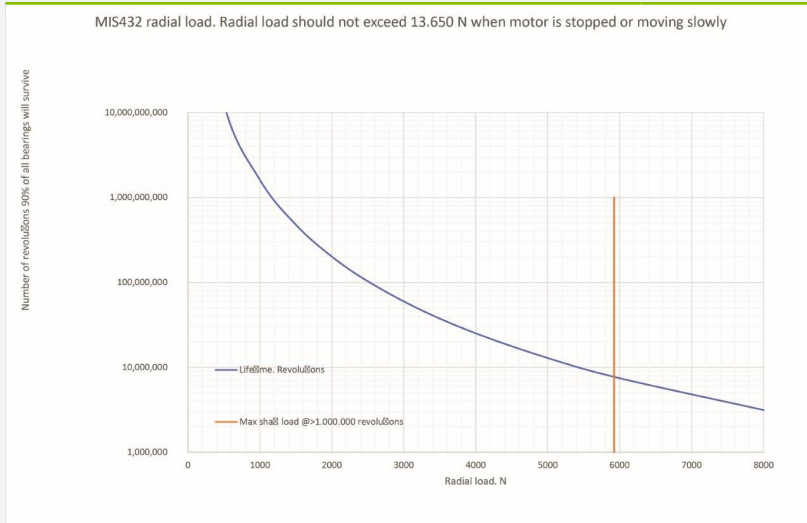

Load typical term	Load Long term
Shaft Seal	



MIS432C22Q5H285

Int.Step 12-72VDC, RS485, EncC-L

Connector information

Connector 1 label	PWR	Connector 1	M12 5-pin male A-coded
Connector 2 label	CN2	Connector 2	M12 5-pin female A-coded
Connector 3 label	CN3	Connector 3	M12 8-pin female A-coded
Connector 4 label	CN4	Connector 4	M12 17-pin female A-coded
Connector 1 RS485	No	Connector 2 RS485	Yes
Connector 3 RS485	Yes	Connector 4 RS485	Yes

Motor connectors

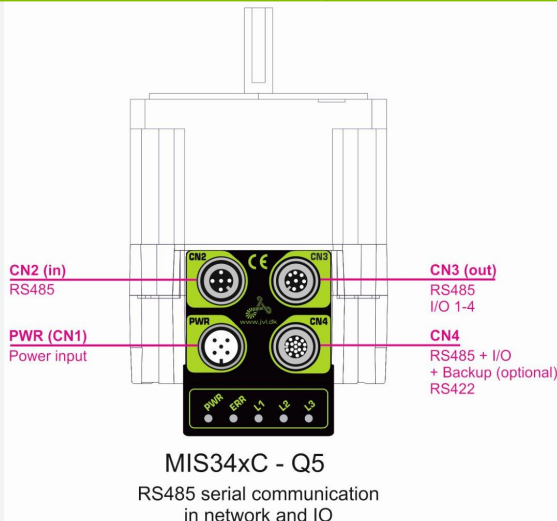

Picture CN1

“PWR” (CN1) - Power input. M12 - 5pin male connector

Signal name	Description	Pin no.	JVL Cable WI1000- M12F5TxxN	Isolation group
P+	Main supply +7-72VDC. Connect with pin 2 *	1	Brown	1
P+	Main supply +7-72VDC. Connect with pin 1 *	2	White	1
P-	Main supply ground. Connect with pin 5 *	3	Blue	1
CVI	Control and user output supply +7-30VDC. DO NOT connect >30V to this terminal!	4	Black	1
P-	Main supply ground. Connect with pin 3 *	5	Grey	1

* Note: P+ and P- are each available at 2 terminals. Make sure that both terminals are connected in order to split the supply current in 2 terminals and thereby avoid an overload of the connector.

Picture CN2

“CN2” - RS485 IN/OUT. M12 - 5pin female connector.

Signal name	Description	Pin no.	JVL Cable WI1000-M12 M5TxxN	Isolation group (See note)
RS485: B0-	RS485 interface. Leave open if unused	1	Brown	1
RS485: A0+	RS485 interface. Leave open if unused	2	White	1
RS485: B0-	RS485 interface. Leave open if unused	3	Blue	1
RS485: A0+	RS485 interface. Leave open if unused	4	Black	1
GND	Ground intended to be used together with the other signals in this connector	5	Grey	1



MIS432C22Q5H285

Int.Step 12-72VDC, RS485, EncC-L

Connector information

Picture CN3

"CN3" - RS485 + I/O connector - M12 - 8pin female connector.				
Signal name	Description	Pin no.	JVL Cable W11000-M12 M8TxxN	Isolation group (See note)
IO1	I/O channel 1. Can be used as input or output	1	White	1
IO2	I/O channel 2. Can be used as input or output	2	Brown	1
IO3	I/O channel 3. Can be used as input or output	3	Green	1
GND	Ground intended to be used together with the other signals in this connector	4	Yellow	1
RS485: B0-	RS485 interface. Leave open if unused	5	Grey	1
RS485: A0+	RS485 interface. Leave open if unused	6	Pink	1
IO4	I/O channel 4. Can be used as input or output	7	Blue	1
CVO	Supply output. Connected internally to the CVI terminal in the PWR connector. Max 700 mA. DO NOT connect >30V to this terminal! USB interface. Supply input 5VDC nominal	8	Red	1

Picture CN4

"CN4" - RS485 + I/O + Backup (option) connector - M12 - 17pin female connector				
Signal name	Description	Pin no.	JVL Cable W11009M12 M17TxxN	Isolation group (see note)
IO1	I/O channel 1. Can be used as input or output	1	Brown	1
GND	Ground intended to be used together with the other signals in this connector	2	Blue	1
IO2	I/O channel 2. Can be used as input or output	3	White	1
IO3	I/O channel 3. Can be used as input or output	4	Green	1
RS422: B1-	RS422 I/O terminal B-	5	Pink	1
IO4	I/O channel 4. Can be used as input or output	6	Yellow	1
RS422: A1-	RS422 I/O terminal A-	7	Black	1
RS422: B1+	RS422 I/O terminal B+	8	Grey	1
CVO	Supply output. Connected internally to the CVI terminal in the PWR connector. DO NOT connect >30V to this terminal!	9	Red	1
RS422: A1+	RS422 I/O terminal A+	10	Violet	1
IO5	I/O channel 5. Can be used as input or output	11	Grey/pink	1
IO6	I/O channel 6. Can be used as input or output	12	Red/blue	1
IO7	I/O channel 7. Can be used as input or output	13	White/Green	1
IO8	I/O channel 8. Can be used as input or output	14	Brown/Green	1
RS485: B0-	RS485 interface. Leave open if unused	15	White/Yellow	1
EXTBACKUP	Only for motors with the -H3 or -H4 option (abs. multiturn encoder). This terminal can be connected to an external supply. Connect to ground (GND) if not used.	16	Yellow/brown	1
RS485: A0+	RS485 interface. Leave open if unused	17	White/grey	1

* Note: Isolation group indicate which terminals/circuits that a galvanic connected to each other. In other words group 1, 2, 3 and 4 are all fully independently isolated from each other. Group 1 correspond to the housing of the motor which may also be connected to earth via the DC or AC input supply.

Connector STO No

Picture STO Con -



MIS432C22Q5H285

Int.Step 12-72VDC, RS485, EncC-L

Torque, force and Power information

Supply Volt 1 [V]		Power Peak 1 [W]	
Supply Volt 2 [V]	24	Power Peak 2 [W]	77.28
Supply Volt 3 [V]	48	Power Peak 3 [W]	172.15
Supply Volt 4 [V]	72	Power Peak 4 [W]	245.35
Holding torque [Nm]	25.0	Running torque [Nm]	25.0
Detent torque [Nm]			

MIS432 motor torque and shaft power versus speed

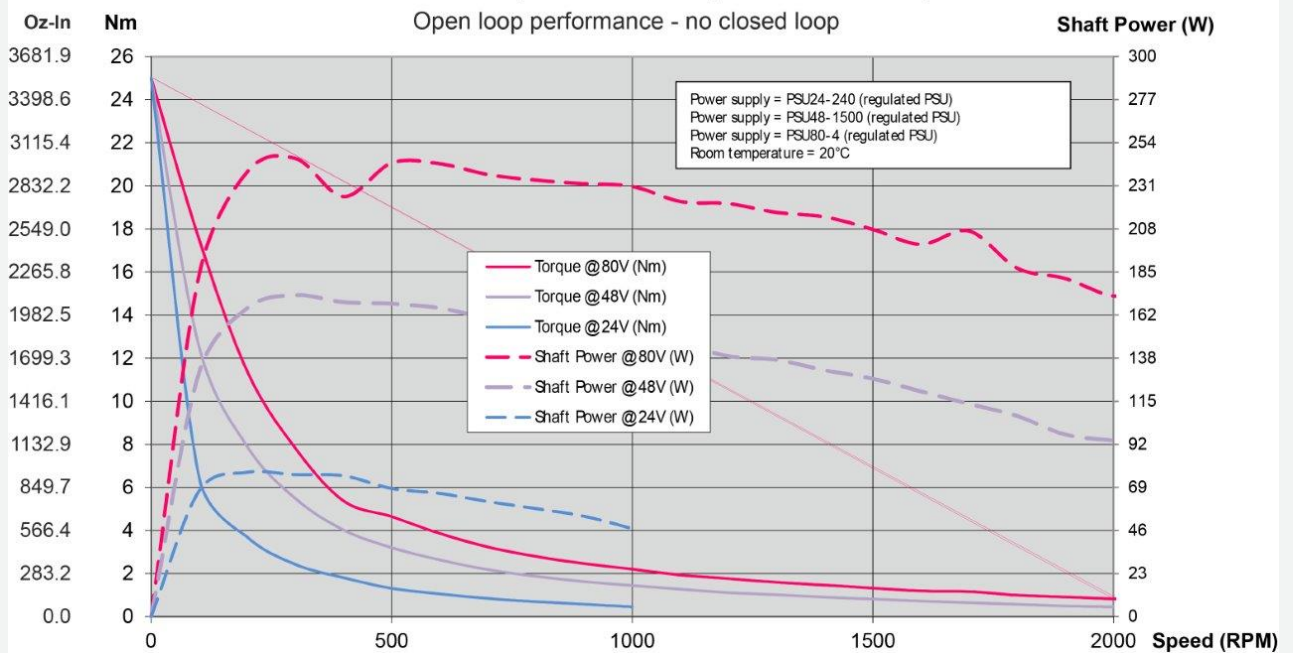



MIS432C22Q5H285

Int.Step 12-72VDC, RS485, EncC-L

Electrical information

Main supply [V]	12-72	Main supply Min-Max [V]	7-90
Rated motor current [A]	5.8		
Control voltage (CVI/O+) [VDC]	7-28	Control Voltage (CVI) Min-Max [VDC]	7-32
CVI current wo Ethernet and output (12/24VDC) [mA]	165/95	Current Ethernet option (12/24VDC) [mA]	-
Current brake option [mA]	-	Current for 1 Dig. output max [mA]	- 350
Max current CVI [A]			
Dig. Input impedans	27 Kohm	Counter frequency max	12MHz
MTBF 30% [Year]	15	MTBF 100% [Year]	13
Motor resolution	409600	Encoder type	H2 Incremental/abs_singleturn
Encoder Resolution (H2) H2 - 4096 Singleturn AbsEnc - Semi multiturn			
Encoder Resolution (H3)	-	Encoder revolutions	+/-5242
PLC no. of DI/DO/AI	8	Analogue voltage	0-5VDC 12bit
Standard used		Standard used 2	
Resistance [Ohm]		Induction [mH]	



MIS432C22Q5H285

Int.Step 12-72VDC, RS485, EncC-L

Communication information

Software	MacTalk	Connector 2 RS485	Yes
Connectivity: Without module	RS485	Connector 3 RS485	Yes
		Connector 4 RS485	Yes

Motor connectors

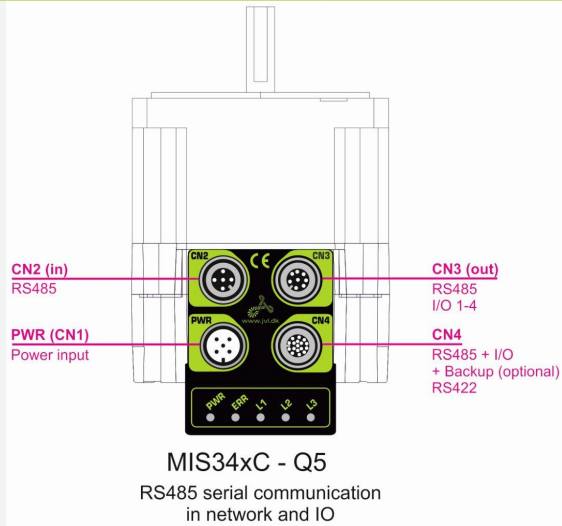

e-PLC Files

Ethernet, PLC demo files



MIS432C22Q5H285

Int.Step 12-72VDC, RS485, EncC-L

Cable information

Item number	Mount on	Cable con 1 +Con 1 angle	Cable application	Wires no totally	Cable length [m]
Item description		Cable con 2 +Con 2 angle	Cable flexibility	Wire [mm2]	Connector 1 LED
WI1000-M12F5T02N M12 Shl Cable 2m 5 pin Fem 0°, Power	Connector 1	M12 5-pin female A-coded - 0° Straight Open Ended - n/a	Power/Motor/com Standard	5 0.32	2 No
WI1000-M12F5T05N M12 Shl Cable 5m 5 pin Fem 0°, Power	Connector 1	M12 5-pin female A-coded - 0° Straight Open Ended - n/a	Power/Motor/com Standard	5 0.32	5 No
WI1000-M12F5T1.2N M12 Shl Cable 1.2m 5 pin Fem 0°, Power	Connector 1	M12 5-pin female A-coded - 0° Straight Open Ended - n/a	Power/Motor/com Standard	5 0.32	1.2 No
WI1000-M12F5T10N M12 Shl Cable 10m 5 pin Fem 0°, Power	Connector 1	M12 5-pin female A-coded - 0° Straight Open Ended - n/a	Power/Motor/com Standard	5 0.32	10 No
WI1000-M12F5T10R M12 Shl Cable 10m 5 pin Fem 0°, Power, High-flex	Connector 1	M12 5-pin female A-coded - 0° Straight Open Ended - n/a	Power/Motor/com Robotic - 3D	5 0.32	10 No
WI1000-M12F5T20N M12 Shl Cable 20m 5 pin Fem 0°, Power	Connector 1	M12 5-pin female A-coded - 0° Straight Open Ended - n/a	Power/Motor/com Standard	5 0.32	20 No
WI1000-M12F5TLT0185 M12 shl Cable 3m 5 pin female 0°,PW SPEC	Connector 1	M12 5-pin female A-coded - 0° Straight - n/a	Power Standard	5 0.32	3 No
WI1000-M12F5V05N M12 Shl Cable 5m 5 pin Fem 90°, Power	Connector 1	M12 5-pin female A-coded - 90° Angled Open Ended - n/a	Power/Motor/com Standard	5 0.32	5 No
WI1000-M12F5V10N M12 Shl Cable 10 m 5 pin Fem 90°, Power	Connector 1	M12 5-pin female A-coded - 90° Angled Open Ended - n/a	Power/Motor/com Standard	5 0.32	10 No
WI1000-M12F5V20N M12 Shl Cable 20m 5 pin Fem 90°, Power	Connector 1	M12 5-pin female A-coded - 90° Angled Open Ended - n/a	Power/Motor/com Standard	5 0.32	20 No
WI1000-M12F5W05N M12 Shl Cable 5m LED 5p Fem 90°, Power <50V	Connector 1	M12 5-pin female A-coded - 90° Angled Open Ended - n/a	Power 24/48 Standard	5 0.32	5 LED
WI1000-M12F5W10N M12 Shl Cable 10m LED 5 p Fem 90°, Power <50V	Connector 1	M12 5-pin female A-coded - 90° Angled Open Ended - n/a	Power 24/48 Standard	5 0.32	10 LED
WI1000-M12F5W15N M12 Shl Cable 15m LED 5 p Fem 90°, Power <50V	Connector 1	M12 5-pin female A-coded - 90° Angled Open Ended - n/a	Power 24/48 Standard	5 0.32	15 LED
WI1000-M12F5W20N M12 Shl Cable 20m LED 5 p Fem 90°, Power <50V	Connector 1	M12 5-pin female A-coded - 90° Angled Open Ended - n/a	Power 24/48 Standard	5 0.32	20 LED
WI1000-M12F5WF5W20N M12 shl cab 20m LED 5 pin female 90',Pow <50V	Connector 1	M12 5-pin female A-coded - 90° Angled M12 5-pin female A-coded - 90° Angled	Power 24/48 Standard	5 0.32	20 LED
WI1008-M12F5SS1 M12 Con 5p Fem 0° Solder assembly	Connector 1	M12 5-pin female A-coded - 0° Straight - n/a	n/a	n/a	Connector No
WI1008-M12F5TG1 M12 Con 5p Fem 0° Spring Shield+B222	Connector 1	M12 5-pin female A-coded - 0° Straight - n/a	n/a	n/a	Connector No
WI1008-M12F5VG1 M12 Con 5p Fem 90° Spring Shield	Connector 1	M12 5-pin female A-coded - 90° Angled - n/a	n/a	n/a	Connector No
WI1000-M12M5A05N M12 cable 5m, 5 pin male 90°, COM2/ B4	Connector 2	M12 5-pin male A-coded - 90° Angled Open Ended - n/a	Communication Standard	5 0.32	5 No
WI1000-M12M5T05N M12 Shl Cable 5m 5 p Male 0°, COM	Connector 2	M12 5-pin male A-coded - 0° Straight Open Ended - n/a	Communication Standard	5 0.32	5 No
WI1000-M12M5T20N M12 Shl Cable 20m 5 p Male 0°, COM	Connector 2	M12 5-pin male A-coded - 0° Straight Open Ended - n/a	Communication Standard	5 0.32	20 No
WI1000-M12M5TF5T.5N M12 Shl Cable .5m 5p Male 0° to 5p Fem 0	Connector 2	M12 5-pin male A-coded - 0° Straight M12 5-pin female A-coded - 0° Straight	Communication Standard	5 0.32	0.5 No
WI1000-M12M5TF5T01N M12 Shl Cable 1m 5p Male 0° to 5p Fem 0°	Connector 2	M12 5-pin male A-coded - 0° Straight M12 5-pin female A-coded - 0° Straight	Communication Standard	5 0.32	1 No
WI1000-M12M5TF5T02N M12 Shl Cable 2m 5p Male 0° to 5p Fem 0°	Connector 2	M12 5-pin male A-coded - 0° Straight M12 5-pin female A-coded - 0° Straight	Communication Standard	5 0.32	2 No
WI1000-M12M5TF5T02T M12 Cable 2m 5pM 180° to 5pF 180° twisted, power c	Connector 2	M12 5-pin male A-coded - 0° Straight M12 5-pin female A-coded - 0° Straight	Communication Standard	5 0.32	2 No
WI1000-M12M5TF5T03N M12 Shl Cable 3m 5p Male 0° to 5p Fem 0°	Connector 2	M12 5-pin male A-coded - 0° Straight M12 5-pin female A-coded - 0° Straight	Communication Standard	5 0.32	3 No
WI1000-M12M5V05N M12 Shl Cable 5m 5 p Male 90°, COM	Connector 2	M12 5-pin male A-coded - 90° Angled Open Ended - n/a	Communication Standard	5 0.32	5 No
WI1000-M12M5V20N	Connector 2	M12 5-pin male A-coded - 90° Angled	Communication	5	20



MIS432C22Q5H285

Int.Step 12-72VDC, RS485, EncC-L

Cable information

Item number	Mount on	Cable con 1 +Con 1 angle	Cable application	Wires no totally	Cable length [m]
Item description		Cable con 2 +Con 2 angle	Cable flexibility	Wire [mm2]	Connector 1 LED
M12 Shl Cable 20m 5 p Male 90°, COM		Open Ended - n/a	Standard	0.32	No
WI1005-M12M5STR6	Connector 2	M12 5-pin male A-coded - 0° Straight	Communication	n/a	Connector
M12 5-pin male A Code Resistor RS485		n/a - n/a	n/a	n/a	No
WI1005-M12M5TF5T.2N	Connector 2	M12 5-pin male A-coded - 0° Straight	Communication		0.2
M12 Cab 0.2m, 5p Mal - 5p Fem, RS485 .Std cable		M12 5-pin male A-coded - 0° Straight	Standard	0.32	No
WI1005-M12M5TM5T01N	Connector 2	M12 5-pin male A-coded - 0° Straight	Communication		1
M12 Cab 1m, 5p Mal - 5p Mal, RS485. Std cable		M12 5-pin male A-coded - 0° Straight	Standard	0.32	No
WI1008-M12M5AC1	Connector 2	M12 5-pin male A-coded - 90° Angled		n/a	Connector
M12 Con 5p Male 90° Screw PG7 for cable		- n/a	n/a	n/a	No
WI1008-M12M5AG1	Connector 2	M12 5-pin male A-coded - 90° Angled		n/a	Connector
M12 Con 5p Male 90° Spring Ø4-8mm cable		- n/a	n/a	n/a	No
WI1008-M12M5SC1	Connector 2	M12 5-pin male A-coded - 0° Straight		n/a	Connector
M12 Con 5p Male 0° Screw PG7 cable		- n/a	n/a	n/a	No
WI1008-M12M5SS1	Connector 2	M12 5-pin male A-coded - 0° Straight		n/a	Connector
M12 Con 5p Male 0° Solder assembly		- n/a	n/a	n/a	No
WI1008-M12M5TC1	Connector 2	M12 5-pin male A-coded - 0° Straight		n/a	Connector
M12 Con 5p Male A-coded Screw Shield		- n/a	n/a	n/a	No
WI1008-M12M5TG1	Connector 2	M12 5-pin male A-coded - 0° Straight		n/a	Connector
M12 Con 5p Male 0° Spring Shield		- n/a	n/a	n/a	No
WI1008-M12M5VG1	Connector 2	M12 5-pin male A-coded - 90° Angled		n/a	Connector
M12 Con 5p Male 90° Spring Shield		- n/a	n/a	n/a	No
WI1000-M12M8T02N	Connector 3	M12 8-pin male A-coded - 0° Straight	Basic I/O, Com	8	2
M12 Shl Cable 2m 8 p Male 0° COM1/Ext IO		Open Ended - n/a	Standard	0.32	No
WI1000-M12M8T05N	Connector 3	M12 8-pin male A-coded - 0° Straight	Basic I/O, Com	8	5
M12 Shl Cable 5m 8 p Male 0° COM1/Ext IO		Open Ended - n/a	Standard	0.32	No
WI1000-M12M8T20N	Connector 3	M12 8-pin male A-coded - 0° Straight	Basic I/O, Com	8	20
M12 Shl Cable 20m 8 p Male 0° COM1/ExtIO		Open Ended - n/a	Standard	0.32	No
WI1000-M12M8TF4LT186	Connector 3	M12 8-pin male A-coded - 0° Straight		8	5
M12 shl cable5m, M12 M8, M8 F4 0° IO		M12 4-pin female A-coded - 0° Straight		0.32	No
WI1000-M12M8TF8T.5N	Connector 3	M12 8-pin male A-coded - 0° Straight		8	0.5
M12 Shl Cable .5m 8p Fem 0° to 8p Male 0		M12 5-pin female A-coded - 0° Straight	Standard	0.32	No
WI1000-M12M8TLT0184	Connector 3	M12 8-pin male A-coded - 0° Straight		8	5
M12 shl cable5m, 8 pin male 0° IO SPEC		M12 4-pin female A-coded - 0° Straight		0.32	No
WI1000-M12M8V05N	Connector 3	M12 8-pin male A-coded - 90° Angled	Basic I/O, Com	8	5
M12 Shl Cable 5m 8 p Mal 90° COM1/ExtIO		Open Ended - n/a	Standard	0.2	No
WI1000-M12M8V20N	Connector 3	M12 8-pin male A-coded - 90° Angled	Basic I/O, Com	8	20
M12 Shl Cable 20m 8 p Mal 90° COM1/ExtIO		Open Ended - n/a	Standard	0.2	No
WI1005-M12M8QM5V.3N	Connector 3	M12 8-pin male A-coded - 90° Angled	Communication		0.3
M12 Shl Cab 0.3m 8p Mal 5p Mal 90° RS485 twisted		M12 5-pin male A-coded - 90° Angled	Standard	0.32	No
WI1005-M12M8S10N	Connector 3	M12 8-pin male A-coded - 0° Straight		8	10
M12 Shl Cable 10m, 8 p Male MAC00-B41 twisted		Open Ended - n/a	Standard	0.32	No
WI1005-M12M8STR5	Connector 3	M12 8-pin male A-coded - 0° Straight	Communication	n/a	Connector
M12 8-pin male A Code Resistor RS485		n/a - n/a	n/a	0.32	No
WI1005-M12M8TF8T20N	Connector 3	M12 8-pin male A-coded - 0° Straight		8	5
M12 Shl Cab 20m 8p Male 8p Female 0° RS485 twisted		M12 8-pin female A-coded - 0° Straight		0.32	No
WI1005-M12M8TM5T.3N	Connector 3	M12 8-pin male A-coded - 0° Straight	Communication	5	0.3
M12 Shl Cab 0,3 m 8p Male 5p Male 0° RS485 twisted		M12 5-pin male A-coded - 0° Straight	Standard	0.32	No
WI1005-M12M8TM5T.5N	Connector 3	M12 8-pin male A-coded - 0° Straight	Communication	5	0.5
M12 Shl Cab 0,5 m 8p Male 5p Male 0° RS485 twisted		M12 5-pin male A-coded - 0° Straight	Standard	0.32	No
WI1005-M12M8TM5T05N	Connector 3	M12 8-pin male A-coded - 0° Straight	Communication	5	5
M12 Shl Cab 5m 8p Male 5p Male 0° RS485 twisted		M12 5-pin male A-coded - 0° Straight	Standard	0.32	No
WI1005-M12M8VM5V.5N	Connector 3	M12 8-pin male A-coded - 90° Angled	Communication	5	0,5
M12 Shl Cab 0.5m 8pMale 5pMale 90° RS485 twisted		M12 5-pin male A-coded - 90° Angled	Standard	0.32	No
WI1005-M12M8VM5V03N	Connector 3	M12 8-pin male A-coded - 90° Angled	Communication	5	3
M12 Shl Cab3m 8p Male 5p Male 90° RS485 twisted		M12 5-pin male A-coded - 90° Angled	Standard	0.32	No



MIS432C22Q5H285

Int.Step 12-72VDC, RS485, EncC-L

Cable information

Item number	Mount on	Cable con 1 +Con 1 angle	Cable application	Wires no totally	Cable length [m]
Item description		Cable con 2 +Con 2 angle	Cable flexibility	Wire [mm2]	Connector 1 LED
WI1005-M12M8VM5V10N M12 Shl Cab10m 8p Male 5p Male 90° RS485 twisted	Connector 3	M12 8-pin male A-coded - 90° Angled M12 5-pin male A-coded - 90° Angled	Communication Standard	5 0.32	10 No
WI1005-M12M8VM5V20N M12 Shl Cab20m 8p Male 5p Male 90° RS485 twisted	Connector 3	M12 8-pin male A-coded - 90° Angled M12 5-pin male A-coded - 90° Angled	Communication Standard	5 0.32	20 No
WI1008-M12M8SC1 M12 Con 8p Male 0° Screw Ø4-8mm cable	Connector 3	M12 8-pin male A-coded - 0° Straight - n/a	n/a n/a	n/a n/a	Connector No
WI1008-M12M8SS1 M12 Con 8p Male 0° Solder assembly	Connector 3	M12 8-pin male A-coded - 0° Straight - n/a	n/a n/a	n/a n/a	Connector No
WI1008-M12M8TC1 M12 Con 8p Male 0° Screw Shield	Connector 3	M12 8-pin male A-coded - 0° Straight - n/a	n/a n/a	n/a n/a	Connector No
WI1008-M12M8TS1 M12 Con 8p Male 0° Solder Shield	Connector 3	M12 8-pin male A-coded - 0° Straight - n/a	n/a n/a	n/a n/a	Connector No
WI1009-M12M8Q1.2N M12 Shl Cable 1.2m 8p Male 90° 4P twisted	Connector 3	M12 8-pin male A-coded - 90° Angled Open Ended - n/a	 Standard	8 0.32	1.2 No
WI1009-M12M8V05N M12 Shl Cable 5m 8 p Male 90° 4P twisted	Connector 3	M12 8-pin male A-coded - 90° Angled Open Ended - n/a	 Standard	8 0.32	5 No
WI1009-M12M8V20N M12 Shl Cable 20m 8 p Male 90° 4P twisted	Connector 3	M12 8-pin male A-coded - 90° Angled Open Ended - n/a	 Standard	8 0.32	20 No
WI1011-M12M8V1.2T M12 Shl Cable 1.2m 8 p Male 90° 4P twisted	Connector 3	M12 8-pin male A-coded - 90° Angled Open Ended - n/a	 Standard	8 0.32	1.2 No
WI1011-M12M8V10T M12 Shl Cable 10m 8 p Male 90° 4P twisted	Connector 3	M12 8-pin male A-coded - 90° Angled Open Ended - n/a	 Standard	8 0.32	10 No
WI1011-M12M8V15T M12 Shl Cable 15m 8 p Male 90° 4P twisted	Connector 3	M12 8-pin male A-coded - 90° Angled Open Ended - n/a	 Standard	8 0.32	15 No
RS485-M12-1-5-8 RS485 M12-8pin DSub, 5m, straight v1.0	Connector 3 RS485	M12 8-pin male A-coded - 0° Straight D-Sub 9-pin female - RS485 - 0° Straight	Communication Cable chains - 2D	3 0.32	5 No
WI1005-M12M17SAA01 M12 17-pin male Axis 1 Without wire	Connector 4	M12 17-pin male A-coded - 0° Straight n/a - n/a	 n/a	n/a n/a	Connector No
WI1005-M12M17SAA01-1 M12 17-pin male Axis 1, with wire 1,2m	Connector 4	M12 17-pin male A-coded - 0° Straight n/a - n/a	 n/a	n/a n/a	Connector No
WI1005-M12M17SAA02 M12 17-pin male Axis 2 Without wire	Connector 4	M12 17-pin male A-coded - 0° Straight n/a - n/a	 n/a	n/a n/a	Connector No
WI1005-M12M17SAA03 M12 17-pin male Axis 3 Without wire	Connector 4	M12 17-pin male A-coded - 0° Straight n/a - n/a	 n/a	n/a n/a	Connector No
WI1005-M12M17SAA04 M12 17-pin male Axis 4 Without wire	Connector 4	M12 17-pin male A-coded - 0° Straight n/a - n/a	 n/a	n/a n/a	Connector No
WI1005-M12M17SAA05 M12 17-pin male Axis 5 Without wire	Connector 4	M12 17-pin male A-coded - 0° Straight n/a - n/a	 n/a	n/a n/a	Connector No
WI1005-M12M17SAA06 M12 17-pin male Axis 6 Without wire	Connector 4	M12 17-pin male A-coded - 0° Straight n/a - n/a	 n/a	n/a n/a	Connector No
WI1005-M12M17SAA06-1 M12 17-pin male Axis 6 with wire 1,2m	Connector 4	M12 17-pin male A-coded - 0° Straight n/a - n/a	 n/a	n/a n/a	Connector No
WI1005-M12M17SAA07 M12 17-pin male Axis 7 Without wire	Connector 4	M12 17-pin male A-coded - 0° Straight n/a - n/a	 n/a	n/a n/a	Connector No
WI1005-M12M17SAA08 M12 17-pin male Axis 8 Without wire	Connector 4	M12 17-pin male A-coded - 0° Straight n/a - n/a	 n/a	n/a n/a	Connector No
WI1005-M12M17SAA09 M12 17-pin male Axis 9 Without wire	Connector 4	M12 17-pin male A-coded - 0° Straight n/a - n/a	 n/a	n/a n/a	Connector No
WI1005-M12M17SAA10 M12 17-pin male Axis 10 Without wire	Connector 4	M12 17-pin male A-coded - 0° Straight n/a - n/a	 n/a	n/a n/a	Connector No
WI1008-M12M17SR1 M12 Con 17p Male 0° Metal housing 5.4-8.2mm cable	Connector 4	M12 12-pin male A-coded - 0° Straight - n/a	 n/a	n/a n/a	Connector No
WI1009-M12M17T01N M12 Shl Cable 1m 17p Mal 0° MISxx,Ex41 twisted	Connector 4	M12 17-pin male A-coded - 0° Straight Open Ended - n/a	Basic I/O, Com Standard	17 0.061	1 No
WI1009-M12M17T05N	Connector 4	M12 17-pin male A-coded - 0° Straight	Basic I/O, Com	17	5



MIS432C22Q5H285

Int.Step 12-72VDC, RS485, EncC-L

Cable information

Item number	Mount on	Cable con 1 +Con 1 angle	Cable application	Wires no totally	Cable length [m]
Item description		Cable con 2 +Con 2 angle	Cable flexibility	Wire [mm2]	Connector 1 LED
M12 Shl Cable 5m 17p Mal 0° MISxx,Ex41 twisted		Open Ended - n/a	Standard	0.061	No
WI1009-M12M17T10R	Connector 4	M12 17-pin male A-coded - 0° Straight		17	5
M12 Shl Cable 10m 17p Mal 0° MISxx,Ex41 twisted		Open Ended - n/a	Robotic - 3D	0.061	No
WI1009-M12M17T20N	Connector 4	M12 17-pin male A-coded - 0° Straight	Basic I/O, Com	17	20
M12 Shl Cable 20m 17p Mal 0° MISxx,Ex41 twisted		Open Ended - n/a	Standard	0.061	No
WI1009-M12M17TF17T.5	Connector 4	M12 17-pin male A-coded - 0° Straight	Basic I/O, Com	17	0.5
M12 Shl Cable.5m Male17p0°-Female 17p0° twist pair		M12 17-pin female A-coded - 0° Straight	Standard	0.061	No
WI1009-M12M17TF17T01	Connector 4	M12 17-pin male A-coded - 0° Straight	Basic I/O, Com	17	1
M12 Shl Cable 1m Male17p0°-Female 17p0° twist pair		M12 17-pin female A-coded - 0° Straight	Standard	0.061	No
WI1009-M12M17TF17T02	Connector 4	M12 17-pin male A-coded - 0° Straight	Basic I/O, Com	17	2
M12 Shl Cable 2m Male17p0°-Female 17p0° twist pair		M12 17-pin female A-coded - 0° Straight	Standard	0.061	No
WI1009-M12M17TF17T03	Connector 4	M12 17-pin male A-coded - 0° Straight	Basic I/O, Com	17	3
M12 Shl Cable 3m Male17p0°-Female 17p0° twist pair		M12 17-pin female A-coded - 0° Straight	Standard	0.061	No
WI1009-M12M17TF17T04	Connector 4	M12 17-pin male A-coded - 0° Straight	Basic I/O, Com	17	4
M12 Shl Cable 4m Male17p0°-Female 17p0° twist pair		M12 17-pin female A-coded - 0° Straight	Standard	0.061	No
WI1009-M12M17V05N	Connector 4	M12 17-pin male A-coded - 90° Angled	Basic I/O, Com	17	5
M12 Shl Cable 5m 17p Mal 90° MISxx,Ex41 twisted		Open Ended - n/a	Standard	0.061	No
WI1009-M12M17V10N	Connector 4	M12 17-pin male A-coded - 90° Angled	Basic I/O, Com	17	10
M12 Shl Cable 10m 17p Mal 90° MISxx,Ex41 twisted		Open Ended - n/a	Standard	0.061	No
RS485-M12-1-5-17	Connector 4 RS485	M12 17-pin male A-coded - 0° Straight	Communication	3	5
RS485 M12-17pin DSub, 5m v1.1		D-Sub 9-pin female - RS485 - 0° Straight	Cable chains - 2D	0,32	No