



MIS232R3EPH466

Int.StepH 12-72VDC, Profinet, AbsC-L

ServoStep MIS is a series of integrated stepper motors with servo control (closed-loop) and up to 3000 RPM.

It consists of NEMA 17..23..34..43 size motors with holding torques from 0.36 Nm up to 25 Nm. All motors are programmable and have 8 I/O points (each can be DI or DO or AI).

Options include:

- incremental (semi-absolute) encoder*). absolute multiturn encoder
- brake module*)
- radial or axial*) connectors
- CANopen
- Ethernet interface w/built-in switch for easy daisy-chaining and all protocols (Profinet. EtherNet/IP. EtherCAT. Sercos. ModbusTCP/UDP. Powerlink).
- Wireless versions are also possible: WLAN or BlueTooth.
- Special shaft versions include double shaft and hollow shaft. contact JVL to learn which combinations are possible.
- Higher IP versions are also available. *) Depending of other options

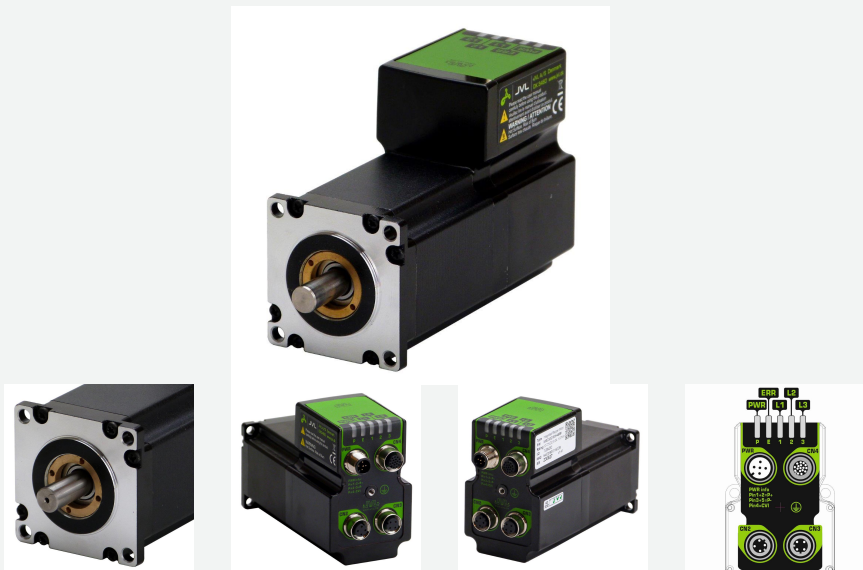

General information



Description	Int.StepH 12-72VDC, Profinet, AbsC-L, 4xM12. 2x4pF:Profinet 17pF:8xDIO/AI +RS422+RS485, High Resolution: 409.600 step/rev. ±0.01 RPM, Programmable (incl. current, position & velocity), C-L + Abs Multiturn Enc. 4096 CPR ± 5242 Revs, ø10x20 mm Round, Shaft: IP42, Motor: IP42, 56.4x124 mm Holding Torque: 2.53 Nm Axial Connector 12-72 VDC Mechanical Power: 316 W, Isolated from earth		
Manufacture	JVL	Motor type	Integrated Stepper - Rotating
Motor resolution	409600	Encoder type	H4: H2 incr+absSingleturn and H3 serial/absMultiturn
Integrated PLC	Yes	PLC no. of DI/DO/AI	8
Closed loop	Yes	STO connector	No
Integrated gear	No	Gear ratio	
Brake	No	Speed [Rpm]	3000.00
Connectivity: Without module	Profinet	Power Peak [W]	316.00
Flange Type Front		Protection House/Shaft	
Shaft size - Front [mm]	10.0 mm		
Running torque [Nm]	2.53	Rated Winding current [A]	6.0
Main supply [V]	12-72	Voltage type - Main	DC



MIS232R3EPH466

Int.StepH 12-72VDC, Profinet, AbsC-L

General information

Control voltage (CVI/O+) [VDC]	7-28	Holding torque [Nm]	2.53
Shaft Double	No		
Weight net [kg]	1.39	MTBF 100% [Year]	13
Weight gross [kg]	1.52	MTBF 30% [Year]	15
Software	MacTalk		
CE Marked	Yes		
			
Approval - ROHS-3	Yes		
			
Approval UL	No		
Tariff no	85015100	Country Of Origin	DK



MIS232R3EPH466

Int.StepH 12-72VDC, Profinet, AbsC-L

Mechanical information

Motor Type	Length (L) ±2.0 [0.0787]	Shaft dia. (D) +0 / -0.013mm[0.000512]
MIS231Q...	103 [4.06]	6.35 [0.25]
MIS232Q...	124 [4.88]	6.35 [0.25]
MIS234Q...	161 [6.34]	10.0 [0.3937]
MIS231R...	103 [4.06]	6.35 [0.25]
MIS232R...	124 [4.88]	10.0 [0.3937]

[] = Inches

This drawing covers only motor type MIS23xQ and MIS23xR with radial connectors

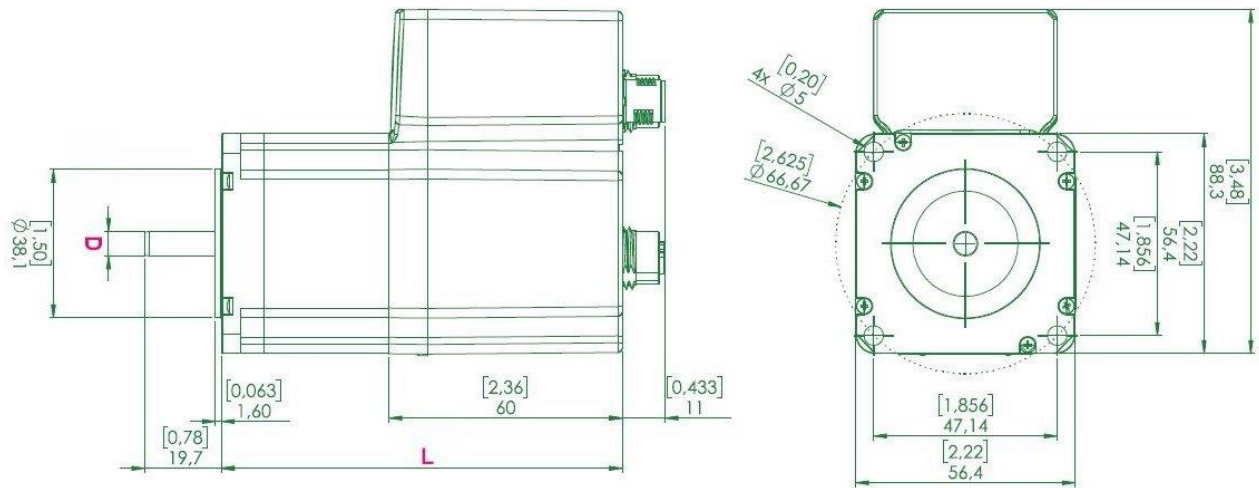

Motor length [mm]	124.0	Motor width [mm]	56.4
Motor height [mm]	88.3	Protection house	IP42
Protection shaft	IP42	Flange Rear	No
Flange Type Front		Flange Type Rear	
Motor diameter center front [mm]	38.1	Motor diameter center rear [mm]	
Bolt circle diameter front [mm]	66.6	Bolt circle diameter front [mm]	
Mounting holes front [mm]	5 mm	Mounting holes rear [mm]	
Flange material	Aluminium	Flange Thickness [mm]	
		Shaft Double	No
Shaft Type Output	Round	Shaft Type Rear	
Shaft size - Front [mm]	10.0 mm	Shaft size - Rear	-
Shaft length Front [mm]	19.7	Shaft length Rear [mm]	
Shaft material	Stainless steel AISI303		
Shaft Key included	Key NOT included	Shaft Key Dimension	-
Front bearing type	6000ZZ	Rear bearing type	6000ZZ
Radial load [N]	346	Radial load distance [mm]	10



MIS232R3EPH466

Int.StepH 12-72VDC, Profinet, AbsC-L

Mechanical information

Axial load [N]	377		
Axial play [mm]		Axial play force [N]	
Integrated gear	No	Gear ratio	
Gear efficiency [%]	-	Gear backlash [ArcMin]	-
Brake	No	Brake - Go ON time [ms]	-
Brake Holding torque [Nm]	-	Brake - Go OFF time [ms]	-
Rotor inertia [kgcm²]	0.48	Max inertia factor	40
Precision Motor - Absolute [Deg]	0.35	Precision Motor - Max Load [Deg]	
Precision Motor - Repeatability [Deg]	0.15	Step angle [°/full step]	1.8°
2D [PDF]	No	2D [DWG]	No
3D [DWG]	No	3D [EASM]	No
3D [IGES]	No	3D [STEP]	No
Datasheet - pdf		CAD file page	Link
User Manual	Download	WEB page	Link
Approval UL	No	STO connector	No
Approval - ATEX	No	Approval TÜV - STO	No
Oil resistant			
Temperature ambient [°C]	0...40 °C and 0...70 °C with derating of performance		
Temperature storage	-40...70 °C		
Humidity working	5...93% non-condensing		
Vibration	5-25 Hz: +/-1.6mm, 25-500Hz: 4G, 1.0 oct./min		
Shock	15G, 30ms. 6 x 1000 cycles in +/-X, +/-Y, +/-Z		
Withstand Voltage	500 VDC between earth and supply ground		
EMC in general	EMC Directive DIR2014/30/EU		
EMC Emission	EN61800-3 / EN61000-6-3 / EN61000-6-4 all 2. enviroment		
EMC Immunity	En IEC 61800-3 / EN61000-6-1 all 2. enviroment		
Safety in general	LVD DIR2014/35/EU / EL61800 - USA and Canada only MIS34x products are pending		
Safety wo STO	EN60950-1		
Safety w STO	EN60950-1 / EN61508-1/-2 SIL3 / ISO13849-1/-2 / ISO62061 / EN61800-5-1/-2		
Inviromental	IEC 60068-2-27, Test Ea. Shock test		
	IEC 60068-2-6, Test Fc. Vibration test		
	IEC 60068-2-2, Test Bd. covers temperaturerise/dry heat		
	IEC 60068-2-78, Perm. moisture/Damp heat, steady state		
REACH SVHC document			
Low voltage Directive			
No Dual Use			



MIS232R3EPH466

Int.StepH 12-72VDC, Profinet, AbsC-L

Mechanical information

Duty Cycle

Max Duty Cycle [%]

Axial Load Typical [N] 377

Axial Load Long [N] 314

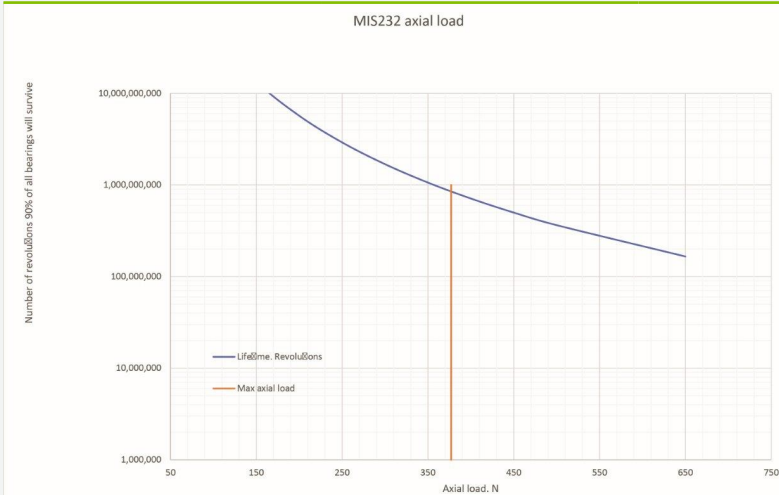

Radial Load Typical [N] 346

Radial Load Long [N] 312

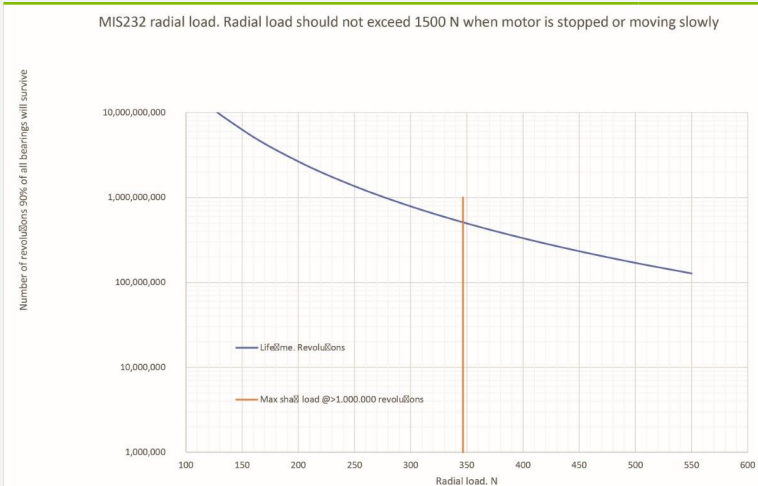

Load typical term

Load Long term

Shaft Seal



MIS232R3EPH466

Int.StepH 12-72VDC, Profinet, AbsC-L

Connector information

Connector 1 label	PWR	Connector 1	M12 5-pin male A-coded
Connector 2 label	CN2	Connector 2	M12 4-pin female D-coded Ethernet
Connector 3 label	CN3	Connector 3	M12 4-pin female D-coded Ethernet
Connector 4 label	CN4	Connector 4	M12 17-pin female A-coded
Connector 1 RS485	No	Connector 2 RS485	No
Connector 3 RS485	No	Connector 4 RS485	Yes

Motor connectors

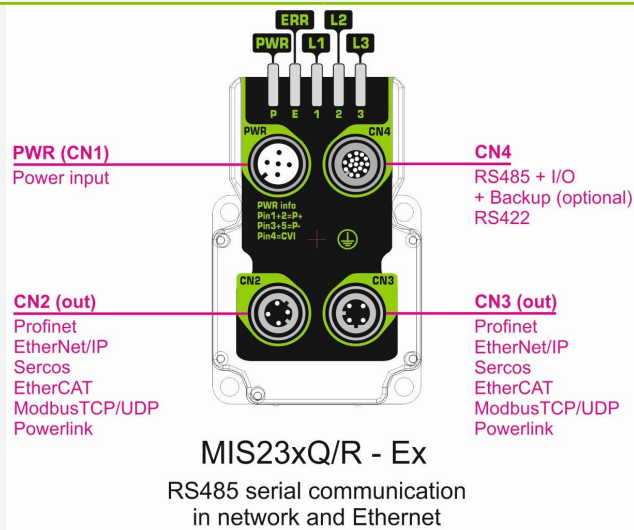

Picture CN1

"PWR" (CN1) - Power input. M12 - 5pin male connector				
Signal name	Description	Pin no.	JVL Cable W11000-M12F5TxxN	Isolation group
P+	Main supply +7-72VDC. Connect with pin 2 *	1	Brown	1
P+	Main supply +7-72VDC. Connect with pin 1 *	2	White	1
P-	Main supply ground. Connect with pin 5 *	3	Blue	1
CVI	Control and user output supply +7-30VDC. DO NOT connect >30V to this terminal!	4	Black	1
P-	Main supply ground. Connect with pin 3 *	5	Grey	1

* Note: P+ and P- are each available at 2 terminals. Make sure that both terminals are connected in order to split the supply current in 2 terminals and thereby avoid an overload of the connector.

Picture CN2

"CN2" - Ethernet In port connector - M12 - 4pin female connector "D" coded				
Signal name	Description	Pin no.	JVL Cable W11046-M12M4S05R	Isolation group (See note)
Tx0_P	Ethernet Transmit channel 0 - positive terminal	1	-	2
Rx0_P	Ethernet Receive channel 0 - positive terminal	2	-	2
Tx0_N	Ethernet Transmit channel 0 - negative terminal	3	-	2
Rx0_N	Ethernet Receive channel 0 - negative terminal	4	-	2



MIS232R3EPH466

Int.StepH 12-72VDC, Profinet, AbsC-L

Connector information

Picture CN3

"CN3" - Ethernet Out port connector. M12 - 4 pin female connector "D" coded				
Signal name	Description	Pin no.	JVL Cable WI1046-M12M4S05R	Isolation group (see note)
Tx1_P	Ethernet Transmit channel 1 - positive terminal	1	-	3
Rx1_P	Ethernet Receive channel 1 - positive terminal	2	-	3
Tx1_N	Ethernet Transmit channel 1 - negative terminal	3	-	3
Rx1_N	Ethernet Receive channel 1 - negative terminal	4	-	3

Picture CN4

"CN4" - RS485 + I/O + Backup (option) connector - M12 - 17pin female connector				
Signal name	Description	Pin no.	JVL Cable WI1009M12 M17TxxN	Isolation group (see note)
IO1	I/O channel 1. Can be used as input or output	1	Brown	1
GND	Ground intended to be used together with the other signals in this connector	2	Blue	1
IO2	I/O channel 2. Can be used as input or output	3	White	1
IO3	I/O channel 3. Can be used as input or output	4	Green	1
RS422: B1-	RS422 I/O terminal B-	5	Pink	1
IO4	I/O channel 4. Can be used as input or output	6	Yellow	1
RS422: A1-	RS422 I/O terminal A-	7	Black	1
RS422: B1+	RS422 I/O terminal B+	8	Grey	1
CVO	Supply output. Connected internally to the CVI terminal in the PWR connector. DO NOT connect >30V to this terminal!	9	Red	1
RS422: A1+	RS422 I/O terminal A+	10	Violet	1
IO5	I/O channel 5. Can be used as input or output	11	Grey/pink	1
IO6	I/O channel 6. Can be used as input or output	12	Red/blue	1
IO7	I/O channel 7. Can be used as input or output	13	White/Green	1
IO8	I/O channel 8. Can be used as input or output	14	Brown/Green	1
RS485: B0-	RS485 interface. Leave open if unused	15	White/Yellow	1
EXTBACKUP	Only for motors with the -H3 or -H4 option (abs. multiturn encoder). This terminal can be connected to an external supply. Connect to ground (GND) if not used.	16	Yellow/brown	1
RS485: A0+	RS485 interface. Leave open if unused	17	White/grey	1

* Note: Isolation group indicate which terminals/circuits that a galvanic connected to each other. In other words group 1, 2, 3 and 4 are all fully independently isolated from each other. Group 1 correspond to the housing of the motor which may also be connected to earth via the DC or AC input supply.

Connector STO No

Picture STO Con -



MIS232R3EPH466

Int.StepH 12-72VDC, Profinet, AbsC-L

Torque, force and Power information

Supply Volt 1 [V]		Power Peak 1 [W]	
Supply Volt 2 [V]	24	Power Peak 2 [W]	103.00
Supply Volt 3 [V]	48	Power Peak 3 [W]	209.00
Supply Volt 4 [V]	72	Power Peak 4 [W]	316.00
Holding torque [Nm]	2.53	Running torque [Nm]	2.53
Detent torque [Nm]	0.068		

MIS232T motor torque and shaft power versus speed

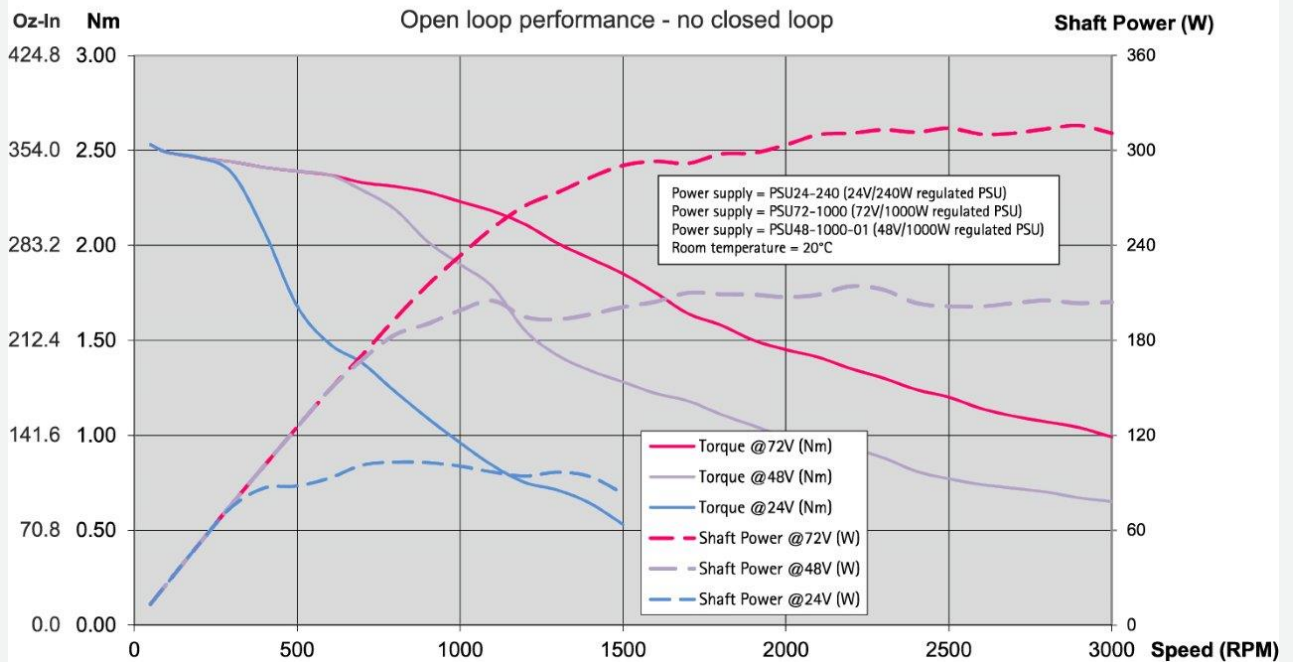



MIS232R3EPH466

Int.StepH 12-72VDC, Profinet, AbsC-L

Electrical information

Main supply [V]	12-72	Main supply Min-Max [V]	7-90
Rated motor current [A]	6.2		
Control voltage (CVI/O+) [VDC]	7-28	Control Voltage (CVI) Min-Max [VDC]	7-30
CVI current wo Ethernet and output (12/24VDC) [mA]	90/55	Current Ethernet option (12/24VDC) [mA]	120/60
Current brake option [mA]	-	Current for 1 Dig. output - max [mA]	350
Max current CVI [A]			
Dig. Input impedans	30 Kohm	Counter frequency max	12MHz
MTBF 30% [Year]	15	MTBF 100% [Year]	13
Motor resolution	409600	Encoder type	H4: H2 incr+absSingleturn and H3 serial/absMultiturn
Encoder Resolution (H2) H2 - 4096 Singleturn AbsEnc - Semi multiturn			
Encoder Resolution (H3)	H3 - 1024 Multiturn AbsEnc	Encoder revolutions	+/-5242
PLC no. of DI/DO/AI	8	Analogue voltage	0-5VDC 12bit
Standard used		Standard used 2	
Resistance [Ohm]		Induction [mH]	



MIS232R3EPH466

Int.StepH 12-72VDC, Profinet, AbsC-L

Communication information

Software	MacTalk	Connector 2 RS485	No
Connectivity: Without module	Profinet	Connector 3 RS485	No
		Connector 4 RS485	Yes

Motor connectors

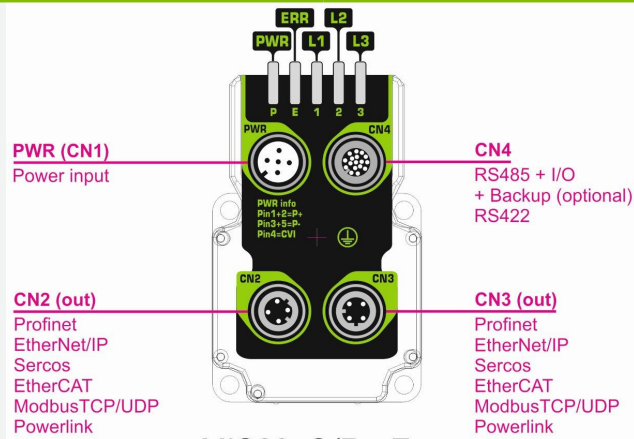

MIS23xQ/R - Ex
RS485 serial communication
in network and Ethernet

e-PLC Files

Ethernet, PLC demo files



MIS232R3EPH466

Int.StepH 12-72VDC, Profinet, AbsC-L

Cable information

Item number	Mount on	Cable con 1 +Con 1 angle	Cable application	Wires no totally	Cable length [m]
Item description		Cable con 2 +Con 2 angle	Cable flexibility	Wire [mm2]	Connector 1 LED
WI1000-M12F5T02N M12 Shl Cable 2m 5 pin Fem 0°, Power	Connector 1	M12 5-pin female A-coded - 0° Straight Open Ended - n/a	Power/Motor/com Standard	5 0.32	2 No
WI1000-M12F5T05N M12 Shl Cable 5m 5 pin Fem 0°, Power	Connector 1	M12 5-pin female A-coded - 0° Straight Open Ended - n/a	Power/Motor/com Standard	5 0.32	5 No
WI1000-M12F5T1.2N M12 Shl Cable 1.2m 5 pin Fem 0°, Power	Connector 1	M12 5-pin female A-coded - 0° Straight Open Ended - n/a	Power/Motor/com Standard	5 0.32	1.2 No
WI1000-M12F5T10N M12 Shl Cable 10m 5 pin Fem 0°, Power	Connector 1	M12 5-pin female A-coded - 0° Straight Open Ended - n/a	Power/Motor/com Standard	5 0.32	10 No
WI1000-M12F5T10R M12 Shl Cable 10m 5 pin Fem 0°, Power, High-flex	Connector 1	M12 5-pin female A-coded - 0° Straight Open Ended - n/a	Power/Motor/com Robotic - 3D	5 0.32	10 No
WI1000-M12F5T20N M12 Shl Cable 20m 5 pin Fem 0°, Power	Connector 1	M12 5-pin female A-coded - 0° Straight Open Ended - n/a	Power/Motor/com Standard	5 0.32	20 No
WI1000-M12F5TLT0185 M12 shl Cable 3m 5 pin female 0°,PW SPEC	Connector 1	M12 5-pin female A-coded - 0° Straight - n/a	Power Standard	5 0.32	3 No
WI1000-M12F5V05N M12 Shl Cable 5m 5 pin Fem 90°, Power	Connector 1	M12 5-pin female A-coded - 90° Angled Open Ended - n/a	Power/Motor/com Standard	5 0.32	5 No
WI1000-M12F5V10N M12 Shl Cable 10 m 5 pin Fem 90°, Power	Connector 1	M12 5-pin female A-coded - 90° Angled Open Ended - n/a	Power/Motor/com Standard	5 0.32	10 No
WI1000-M12F5V20N M12 Shl Cable 20m 5 pin Fem 90°, Power	Connector 1	M12 5-pin female A-coded - 90° Angled Open Ended - n/a	Power/Motor/com Standard	5 0.32	20 No
WI1000-M12F5W05N M12 Shl Cable 5m LED 5p Fem 90°, Power <50V	Connector 1	M12 5-pin female A-coded - 90° Angled Open Ended - n/a	Power 24/48 Standard	5 0.32	5 LED
WI1000-M12F5W10N M12 Shl Cable 10m LED 5 p Fem 90°, Power <50V	Connector 1	M12 5-pin female A-coded - 90° Angled Open Ended - n/a	Power 24/48 Standard	5 0.32	10 LED
WI1000-M12F5W15N M12 Shl Cable 15m LED 5 p Fem 90°, Power <50V	Connector 1	M12 5-pin female A-coded - 90° Angled Open Ended - n/a	Power 24/48 Standard	5 0.32	15 LED
WI1000-M12F5W20N M12 Shl Cable 20m LED 5 p Fem 90°, Power <50V	Connector 1	M12 5-pin female A-coded - 90° Angled Open Ended - n/a	Power 24/48 Standard	5 0.32	20 LED
WI1000-M12F5WF5W20N M12 shl cab 20m LED 5 pin female 90',Pow <50V	Connector 1	M12 5-pin female A-coded - 90° Angled M12 5-pin female A-coded - 90° Angled	Power 24/48 Standard	5 0.32	20 LED
WI1008-M12F5SS1 M12 Con 5p Fem 0° Solder assembly	Connector 1	M12 5-pin female A-coded - 0° Straight - n/a	n/a	n/a	Connector No
WI1008-M12F5TG1 M12 Con 5p Fem 0° Spring Shield+B222	Connector 1	M12 5-pin female A-coded - 0° Straight - n/a	n/a	n/a	Connector No
WI1008-M12F5VG1 M12 Con 5p Fem 90° Spring Shield	Connector 1	M12 5-pin female A-coded - 90° Angled - n/a	n/a	n/a	Connector No
WI1046-M12M4S.3NRJ45 M12 Cab D-code Ethernet M0°-RJ45, 0.3m, Ø5	Connector 2	M12 4-pin male D-coded Ethernet - 0° Straight RJ45 male - 0° Straight	Ethernet Standard	4 0.13	0.3 No
WI1046-M12M4S01NRJ45 M12 Cab D-code Ethernet M0°-RJ45, 1.0m, Ø5	Connector 2	M12 4-pin male D-coded Ethernet - 0° Straight RJ45 male - 0° Straight	Ethernet Standard	4 0.13	1 No
WI1046-M12M4S05NRJ45 M12 Cab D-code Ethernet M0°-RJ45, SFTP, 5m, Ø5	Connector 2	M12 4-pin male D-coded Ethernet - 0° Straight RJ45 male - 0° Straight	Ethernet Standard	4 0.13	5 No
WI1046-M12M4S05R M12 Cab D-code Ethernet M0°, SFTP, 5m Ø7	Connector 2	M12 4-pin male D-coded Ethernet - 0° Straight Open Ended - n/a	Ethernet Cable chains - 2D	4 0.13	5 No
WI1046-M12M4S10NRJ45 M12 Cab D-code Ethernet M0°-RJ45, 10m, Ø5	Connector 2	M12 4-pin male D-coded Ethernet - 0° Straight RJ45 male - 0° Straight	Ethernet Standard	4 0.13	10 No
WI1046-M12M4S15NRJ45 M12 Cab D-code Ethernet M0°-RJ45, 15m, RJ45 Ø5	Connector 2	M12 4-pin male D-coded Ethernet - 0° Straight RJ45 male - 0° Straight	Ethernet Standard	4 0.13	15 No
WI1046-M12M4S15R M12 Cab D-code Ethernet M0°, 15m Ø7	Connector 2	M12 4-pin male D-coded Ethernet - 0° Straight Open Ended - n/a	Ethernet Cable chains - 2D	4 0.13	15 No
WI1046-M12M4T.3TRJ45 M12 Cab D-code Ethernet M0°-RJ45, 0.3m, RJ45 Ø5	Connector 2	M12 4-pin male D-coded Ethernet - 0° Straight RJ45 male - 0° Straight	Ethernet Standard	4 0.13	0.3 No
WI1046-M12M4T01TRJ45 M12 Cab D-code Ethernet M0°-RJ45, 1m, RJ45 Ø5	Connector 2	M12 4-pin male D-coded Ethernet - 0° Straight RJ45 male - 0° Straight	Ethernet Standard	4 0.13	1 No
WI1046-M12M4T02NRJ45	Connector 2	M12 4-pin male D-coded Ethernet - 0° Straight	Ethernet	4	2



MIS232R3EPH466

Int.StepH 12-72VDC, Profinet, AbsC-L

Cable information

Item number	Mount on	Cable con 1 +Con 1 angle	Cable application	Wires no totally	Cable length [m]
Item description		Cable con 2 +Con 2 angle	Cable flexibility	Wire [mm2]	Connector 1 LED
M12 Cab D-code Ethernet M0°-RJ45, 2m, Ø5		RJ45 male - 0° Straight	Standard	0.13	No
WI1046-M12M4T05TRJ45	Connector 2	M12 4-pin male D-coded Ethernet - 0° Straight	Ethernet	4	5
M12 Cab D-code Ethernet M0°-RJ45, 5m, Ø5		RJ45 male - 0° Straight	Standard	0.13	No
WI1046-M12M4T10TRJ45	Connector 2	M12 4-pin male D-coded Ethernet - 0° Straight	Ethernet	4	10
M12 Cab D-code Ethernet M0°-RJ45, 10m, Ø5		RJ45 male - 0° Straight	Standard	0.13	No
WI1046-M12M4T15TRJ45	Connector 2	M12 4-pin male D-coded Ethernet - 0° Straight	Ethernet	4	15
M12 Cab D-code Ethernet M0°-RJ45, SFTP, 15m, Ø5		RJ45 male - 0° Straight	Standard	0.13	No
WI1046-M12M4T20TRJ45	Connector 2	M12 4-pin male D-coded Ethernet - 0° Straight	Ethernet	4	20
M12 Cab D-code Ethernet M0°-RJ45, 20m, Ø5		RJ45 male - 0° Straight	Standard	0.13	No
WI1046-M12M4TM4T.3R	Connector 2	M12 4-pin male D-coded Ethernet - 0° Straight	Ethernet	4	0.3
M12 Cab D-code Ethernet M0°-M0°, 0,3m, Ø6		M12 4-pin male D-coded Ethernet - 0° Straight	Robotic - 3D	0.14	No
WI1046-M12M4TM4T.3T	Connector 2	M12 4-pin male D-coded Ethernet - 0° Straight	Ethernet	4	0.3
M12 Cab D-code Ethernet M0°-M0°, 0,3m, Ø6		M12 4-pin male D-coded Ethernet - 0° Straight	Standard	0.13	No
WI1046-M12M4TM4T01R	Connector 2	M12 4-pin male D-coded Ethernet - 0° Straight	Ethernet	4	1
M12 Cab D-code Ethernet M0°-M0°, 1m, Ø7		M12 4-pin male D-coded Ethernet - 0° Straight	Robotic - 3D	0.14	No
WI1046-M12M4TM4T01T	Connector 2	M12 4-pin male D-coded Ethernet - 0° Straight	Ethernet	4	1
M12 Cab D-code Ethernet M0°-M0°, 1m, Ø6		M12 4-pin male D-coded Ethernet - 0° Straight	Standard	0.13	No
WI1046-M12M4TM4T02R	Connector 2	M12 4-pin male D-coded Ethernet - 0° Straight	Ethernet	4	2
M12 Cab D-code Ethernet M0°-M0°, 2,0m, Ø7		M12 4-pin male D-coded Ethernet - 0° Straight	Robotic - 3D	0.14	No
WI1046-M12M4TM4T02T	Connector 2	M12 4-pin male D-coded Ethernet - 0° Straight	Ethernet	4	2
M12 Cab D-code Ethernet M0°-M0°, 2,0m, Ø6		M12 4-pin male D-coded Ethernet - 0° Straight	Standard	0.13	No
WI1046-M12M4TM4T05R	Connector 2	M12 4-pin male D-coded Ethernet - 0° Straight	Ethernet	4	5
M12 Cab D-code Ethernet M0°-M0°, 5m, Ø7		M12 4-pin male D-coded Ethernet - 0° Straight	Robotic - 3D	0.14	No
WI1046-M12M4TM4T05T	Connector 2	M12 4-pin male D-coded Ethernet - 0° Straight	Ethernet	4	5
M12 Cab D-code Ethernet M0°-M0°, 5m, Ø6		M12 4-pin male D-coded Ethernet - 0° Straight	Standard	0.13	No
WI1046-M12M4TM4T10R	Connector 2	M12 4-pin male D-coded Ethernet - 0° Straight	Ethernet	4	10
M12 Cab D-code Ethernet M0°-M0°, 10m, Ø7		M12 4-pin male D-coded Ethernet - 0° Straight	Robotic - 3D	0.14	No
WI1046-M12M4TM4T10T	Connector 2	M12 4-pin male D-coded Ethernet - 0° Straight	Ethernet	4	10
M12 Cab D-code Ethernet M0°-M0°, 10m, Ø6		M12 4-pin male D-coded Ethernet - 0° Straight	Standard	0.13	No
WI1046-M12M4TM4T15R	Connector 2	M12 4-pin male D-coded Ethernet - 0° Straight	Ethernet	4	15
M12 Cab D-code Ethernet M0°-M0°, 15m, Ø7		M12 4-pin male D-coded Ethernet - 0° Straight	Robotic - 3D	0.14	No
WI1046-M12M4TM4T20R	Connector 2	M12 4-pin male D-coded Ethernet - 0° Straight	Ethernet	4	20
M12 Cab D-code Ethernet M0°-M0°, 20m, Ø7		M12 4-pin male D-coded Ethernet - 0° Straight	Robotic - 3D	0.14	No
WI1046-M12M4TM4T20T	Connector 2	M12 4-pin male D-coded Ethernet - 0° Straight	Ethernet	4	20
M12 Cab D-code Ethernet M0°-M0°, 20m, Ø6		M12 4-pin male D-coded Ethernet - 0° Straight	Standard	0.13	No
WI1046-M12M4V02TRJ45	Connector 2	M12 4-pin male D-coded Ethernet - 90° Angled	Ethernet	4	2
M12 Cab D-code Ethernet M90°-RJ45, 2m, Ø5		RJ45 male - 0° Straight	Standard	0.13	No
WI1046-M12M4V05TRJ45	Connector 2	M12 4-pin male D-coded Ethernet - 90° Angled	Ethernet	4	5
M12 Cab D-code Ethernet M90°-RJ45, 5m, Ø6		RJ45 male - 0° Straight	Standard	0.13	No
WI1046-M12M4VM4T.6N	Connector 2	M12 4-pin male D-coded Ethernet - 90° Angled	Ethernet	4	0.6
M12 Cab D-code Ethernet M90°-M0°, 0,6m, Ø6		M12 4-pin male D-coded Ethernet - 0° Straight	Standard	0.13	No
WI1046-M12M4VM4V.6N	Connector 2	M12 4-pin male D-coded Ethernet - 90° Angled	Ethernet	4	0.6
M12 Cab D-code Ethernet M90°-M90°, 0,6m, Ø6		M12 4-pin male D-coded Ethernet - 90° Angled	Standard	0.13	No
WI1048-M12M4TTR1	Connector 2	M12 4-pin male D-coded Ethernet - 0° Straight	Ethernet		Connector
M12 Con 4 p Male D Code Ethernet PressLock		- n/a	n/a		No
WI1046-M12M4TM4T.3R	Connector 2-2	M12 4-pin male D-coded Ethernet - 0° Straight	Ethernet	4	0.3
M12 Cab D-code Ethernet M0°-M0°, 0,3m, Ø6		M12 4-pin male D-coded Ethernet - 0° Straight	Robotic - 3D	0.14	No
WI1046-M12M4TM4T.3T	Connector 2-2	M12 4-pin male D-coded Ethernet - 0° Straight	Ethernet	4	0.3
M12 Cab D-code Ethernet M0°-M0°, 0,3m, Ø6		M12 4-pin male D-coded Ethernet - 0° Straight	Standard	0.13	No
WI1046-M12M4TM4T01R	Connector 2-2	M12 4-pin male D-coded Ethernet - 0° Straight	Ethernet	4	1
M12 Cab D-code Ethernet M0°-M0°, 1m, Ø7		M12 4-pin male D-coded Ethernet - 0° Straight	Robotic - 3D	0.14	No
WI1046-M12M4TM4T01T	Connector 2-2	M12 4-pin male D-coded Ethernet - 0° Straight	Ethernet	4	1
M12 Cab D-code Ethernet M0°-M0°, 1m, Ø6		M12 4-pin male D-coded Ethernet - 0° Straight	Standard	0.13	No
WI1046-M12M4TM4T02R	Connector 2-2	M12 4-pin male D-coded Ethernet - 0° Straight	Ethernet	4	2
M12 Cab D-code Ethernet M0°-M0°, 2,0m, Ø7		M12 4-pin male D-coded Ethernet - 0° Straight	Robotic - 3D	0.14	No



MIS232R3EPH466

Int.StepH 12-72VDC, Profinet, AbsC-L

Cable information

Item number	Mount on	Cable con 1 +Con 1 angle	Cable application	Wires no totally	Cable length [m]
Item description		Cable con 2 +Con 2 angle	Cable flexibility	Wire [mm2]	Connector 1 LED
WI1046-M12M4TM4T02T	Connector 2-2	M12 4-pin male D-coded Ethernet - 0° Straight	Ethernet	4	2
M12 Cab D-code Ethernet M0°-M0°, 2,0m, Ø6		M12 4-pin male D-coded Ethernet - 0° Straight	Standard	0.13	No
WI1046-M12M4TM4T05R	Connector 2-2	M12 4-pin male D-coded Ethernet - 0° Straight	Ethernet	4	5
M12 Cab D-code Ethernet M0°-M0°, 5m, Ø7		M12 4-pin male D-coded Ethernet - 0° Straight	Robotic - 3D	0.14	No
WI1046-M12M4TM4T05T	Connector 2-2	M12 4-pin male D-coded Ethernet - 0° Straight	Ethernet	4	5
M12 Cab D-code Ethernet M0°-M0°, 5m, Ø6		M12 4-pin male D-coded Ethernet - 0° Straight	Standard	0.13	No
WI1046-M12M4TM4T10R	Connector 2-2	M12 4-pin male D-coded Ethernet - 0° Straight	Ethernet	4	10
M12 Cab D-code Ethernet M0°-M0°, 10m, Ø7		M12 4-pin male D-coded Ethernet - 0° Straight	Robotic - 3D	0.14	No
WI1046-M12M4TM4T10T	Connector 2-2	M12 4-pin male D-coded Ethernet - 0° Straight	Ethernet	4	10
M12 Cab D-code Ethernet M0°-M0°, 10m, Ø6		M12 4-pin male D-coded Ethernet - 0° Straight	Standard	0.13	No
WI1046-M12M4TM4T15R	Connector 2-2	M12 4-pin male D-coded Ethernet - 0° Straight	Ethernet	4	15
M12 Cab D-code Ethernet M0°-M0°, 15m, Ø7		M12 4-pin male D-coded Ethernet - 0° Straight	Robotic - 3D	0.14	No
WI1046-M12M4TM4T20R	Connector 2-2	M12 4-pin male D-coded Ethernet - 0° Straight	Ethernet	4	20
M12 Cab D-code Ethernet M0°-M0°, 20m, Ø7		M12 4-pin male D-coded Ethernet - 0° Straight	Robotic - 3D	0.14	No
WI1046-M12M4TM4T20T	Connector 2-2	M12 4-pin male D-coded Ethernet - 0° Straight	Ethernet	4	20
M12 Cab D-code Ethernet M0°-M0°, 20m, Ø6		M12 4-pin male D-coded Ethernet - 0° Straight	Standard	0.13	No
WI1046-M12M4VM4T.6N	Connector 2-2	M12 4-pin male D-coded Ethernet - 90° Angled	Ethernet	4	0.6
M12 Cab D-code Ethernet M90°-M0°, 0,6m, Ø6		M12 4-pin male D-coded Ethernet - 0° Straight	Standard	0.13	No
WI1046-M12M4VM4V.6N	Connector 2-2	M12 4-pin male D-coded Ethernet - 90° Angled	Ethernet	4	0.6
M12 Cab D-code Ethernet M90°-M90°, 0,6m, Ø6		M12 4-pin male D-coded Ethernet - 90° Angled	Standard	0.13	No
WI1046-M12M4S.3NRJ45	Connector 3	M12 4-pin male D-coded Ethernet - 0° Straight	Ethernet	4	0.3
M12 Cab D-code Ethernet M0°-RJ45, 0,3m, Ø5		RJ45 male - 0° Straight	Standard	0.13	No
WI1046-M12M4S01NRJ45	Connector 3	M12 4-pin male D-coded Ethernet - 0° Straight	Ethernet	4	1
M12 Cab D-code Ethernet M0°-RJ45, 1,0m, Ø5		RJ45 male - 0° Straight	Standard	0.13	No
WI1046-M12M4S05NRJ45	Connector 3	M12 4-pin male D-coded Ethernet - 0° Straight	Ethernet	4	5
M12 Cab D-code Ethernet M0°-RJ45, SFTP, 5m, Ø5		RJ45 male - 0° Straight	Standard	0.13	No
WI1046-M12M4S05R	Connector 3	M12 4-pin male D-coded Ethernet - 0° Straight	Ethernet	4	5
M12 Cab D-code Ethernet M0°, SFTP, 5m Ø7		Open Ended - n/a	Cable chains - 2D	0.13	No
WI1046-M12M4S10NRJ45	Connector 3	M12 4-pin male D-coded Ethernet - 0° Straight	Ethernet	4	10
M12 Cab D-code Ethernet M0°-RJ45, 10m, Ø5		RJ45 male - 0° Straight	Standard	0.13	No
WI1046-M12M4S15NRJ45	Connector 3	M12 4-pin male D-coded Ethernet - 0° Straight	Ethernet	4	15
M12 Cab D-code Ethernet M0°-RJ45, 15m, RJ45 Ø5		RJ45 male - 0° Straight	Standard	0.13	No
WI1046-M12M4S15R	Connector 3	M12 4-pin male D-coded Ethernet - 0° Straight	Ethernet	4	15
M12 Cab D-code Ethernet M0°, 15m Ø7		Open Ended - n/a	Cable chains - 2D	0.13	No
WI1046-M12M4T.3TRJ45	Connector 3	M12 4-pin male D-coded Ethernet - 0° Straight	Ethernet	4	0.3
M12 Cab D-code Ethernet M0°-RJ45, 0,3m, RJ45 Ø5		RJ45 male - 0° Straight	Standard	0.13	No
WI1046-M12M4T01TRJ45	Connector 3	M12 4-pin male D-coded Ethernet - 0° Straight	Ethernet	4	1
M12 Cab D-code Ethernet M0°-RJ45, 1m, RJ45 Ø5		RJ45 male - 0° Straight	Standard	0.13	No
WI1046-M12M4T02NRJ45	Connector 3	M12 4-pin male D-coded Ethernet - 0° Straight	Ethernet	4	2
M12 Cab D-code Ethernet M0°-RJ45, 2m, Ø5		RJ45 male - 0° Straight	Standard	0.13	No
WI1046-M12M4T05TRJ45	Connector 3	M12 4-pin male D-coded Ethernet - 0° Straight	Ethernet	4	5
M12 Cab D-code Ethernet M0°-RJ45, 5m, Ø5		RJ45 male - 0° Straight	Standard	0.13	No
WI1046-M12M4T10TRJ45	Connector 3	M12 4-pin male D-coded Ethernet - 0° Straight	Ethernet	4	10
M12 Cab D-code Ethernet M0°-RJ45, 10m, Ø5		RJ45 male - 0° Straight	Standard	0.13	No
WI1046-M12M4T15TRJ45	Connector 3	M12 4-pin male D-coded Ethernet - 0° Straight	Ethernet	4	15
M12 Cab D-code Ethernet M0°-RJ45, SFTP, 15m, Ø5		RJ45 male - 0° Straight	Standard	0.13	No
WI1046-M12M4T20TRJ45	Connector 3	M12 4-pin male D-coded Ethernet - 0° Straight	Ethernet	4	20
M12 Cab D-code Ethernet M0°-RJ45, 20m, Ø5		RJ45 male - 0° Straight	Standard	0.13	No
WI1046-M12M4TM4T.3R	Connector 3	M12 4-pin male D-coded Ethernet - 0° Straight	Ethernet	4	0.3
M12 Cab D-code Ethernet M0°-M0°, 0,3m, Ø6		M12 4-pin male D-coded Ethernet - 0° Straight	Robotic - 3D	0.14	No
WI1046-M12M4TM4T.3T	Connector 3	M12 4-pin male D-coded Ethernet - 0° Straight	Ethernet	4	0.3
M12 Cab D-code Ethernet M0°-M0°, 0,3m, Ø6		M12 4-pin male D-coded Ethernet - 0° Straight	Standard	0.13	No
WI1046-M12M4TM4T01R	Connector 3	M12 4-pin male D-coded Ethernet - 0° Straight	Ethernet	4	1
M12 Cab D-code Ethernet M0°-M0°, 1m, Ø7		M12 4-pin male D-coded Ethernet - 0° Straight	Robotic - 3D	0.14	No
WI1046-M12M4TM4T01T	Connector 3	M12 4-pin male D-coded Ethernet - 0° Straight	Ethernet	4	1



MIS232R3EPH466

Int.StepH 12-72VDC, Profinet, AbsC-L

Cable information

Item number	Mount on	Cable con 1 +Con 1 angle	Cable application	Wires no totally	Cable length [m]
Item description		Cable con 2 +Con 2 angle	Cable flexibility	Wire [mm2]	Connector 1 LED
M12 Cab D-code Ethernet M0°-M0°, 1m, Ø6		M12 4-pin male D-coded Ethernet - 0° Straight	Standard	0.13	No
WI1046-M12M4TM4T02R	Connector 3	M12 4-pin male D-coded Ethernet - 0° Straight	Ethernet	4	2
M12 Cab D-code Ethernet M0°-M0°, 2,0m, Ø7		M12 4-pin male D-coded Ethernet - 0° Straight	Robotic - 3D	0.14	No
WI1046-M12M4TM4T02T	Connector 3	M12 4-pin male D-coded Ethernet - 0° Straight	Ethernet	4	2
M12 Cab D-code Ethernet M0°-M0°, 2,0m, Ø6		M12 4-pin male D-coded Ethernet - 0° Straight	Standard	0.13	No
WI1046-M12M4TM4T05R	Connector 3	M12 4-pin male D-coded Ethernet - 0° Straight	Ethernet	4	5
M12 Cab D-code Ethernet M0°-M0°, 5m, Ø7		M12 4-pin male D-coded Ethernet - 0° Straight	Robotic - 3D	0.14	No
WI1046-M12M4TM4T05T	Connector 3	M12 4-pin male D-coded Ethernet - 0° Straight	Ethernet	4	5
M12 Cab D-code Ethernet M0°-M0°, 5m, Ø6		M12 4-pin male D-coded Ethernet - 0° Straight	Standard	0.13	No
WI1046-M12M4TM4T10R	Connector 3	M12 4-pin male D-coded Ethernet - 0° Straight	Ethernet	4	10
M12 Cab D-code Ethernet M0°-M0°, 10m, Ø7		M12 4-pin male D-coded Ethernet - 0° Straight	Robotic - 3D	0.14	No
WI1046-M12M4TM4T10T	Connector 3	M12 4-pin male D-coded Ethernet - 0° Straight	Ethernet	4	10
M12 Cab D-code Ethernet M0°-M0°, 10m, Ø6		M12 4-pin male D-coded Ethernet - 0° Straight	Standard	0.13	No
WI1046-M12M4TM4T15R	Connector 3	M12 4-pin male D-coded Ethernet - 0° Straight	Ethernet	4	15
M12 Cab D-code Ethernet M0°-M0°, 15m, Ø7		M12 4-pin male D-coded Ethernet - 0° Straight	Robotic - 3D	0.14	No
WI1046-M12M4TM4T20R	Connector 3	M12 4-pin male D-coded Ethernet - 0° Straight	Ethernet	4	20
M12 Cab D-code Ethernet M0°-M0°, 20m, Ø7		M12 4-pin male D-coded Ethernet - 0° Straight	Robotic - 3D	0.14	No
WI1046-M12M4TM4T20T	Connector 3	M12 4-pin male D-coded Ethernet - 0° Straight	Ethernet	4	20
M12 Cab D-code Ethernet M0°-M0°, 20m, Ø6		M12 4-pin male D-coded Ethernet - 0° Straight	Standard	0.13	No
WI1046-M12M4V02TRJ45	Connector 3	M12 4-pin male D-coded Ethernet - 90° Angled	Ethernet	4	2
M12 Cab D-code Ethernet M90°-RJ45, 2m, Ø5		RJ45 male - 0° Straight	Standard	0.13	No
WI1046-M12M4V05TRJ45	Connector 3	M12 4-pin male D-coded Ethernet - 90° Angled	Ethernet	4	5
M12 Cab D-code Ethernet M90°-RJ45, 5m, Ø6		RJ45 male - 0° Straight	Standard	0.13	No
WI1046-M12M4VM4T.6N	Connector 3	M12 4-pin male D-coded Ethernet - 90° Angled	Ethernet	4	0.6
M12 Cab D-code Ethernet M90°-M0°, 0,6m, Ø6		M12 4-pin male D-coded Ethernet - 0° Straight	Standard	0.13	No
WI1046-M12M4VM4V.6N	Connector 3	M12 4-pin male D-coded Ethernet - 90° Angled	Ethernet	4	0.6
M12 Cab D-code Ethernet M90°-M90°, 0,6m, Ø6		M12 4-pin male D-coded Ethernet - 90° Angled	Standard	0.13	No
WI1048-M12M4TTR1	Connector 3	M12 4-pin male D-coded Ethernet - 0° Straight	Ethernet		Connector
M12 Con 4 p Male D Code Ethernet PressLock		- n/a	n/a		No
WI1046-M12M4TM4T.3R	Connector 3-2	M12 4-pin male D-coded Ethernet - 0° Straight	Ethernet	4	0.3
M12 Cab D-code Ethernet M0°-M0°, 0,3m, Ø6		M12 4-pin male D-coded Ethernet - 0° Straight	Robotic - 3D	0.14	No
WI1046-M12M4TM4T.3T	Connector 3-2	M12 4-pin male D-coded Ethernet - 0° Straight	Ethernet	4	0.3
M12 Cab D-code Ethernet M0°-M0°, 0,3m, Ø6		M12 4-pin male D-coded Ethernet - 0° Straight	Standard	0.13	No
WI1046-M12M4TM4T01R	Connector 3-2	M12 4-pin male D-coded Ethernet - 0° Straight	Ethernet	4	1
M12 Cab D-code Ethernet M0°-M0°, 1m, Ø7		M12 4-pin male D-coded Ethernet - 0° Straight	Robotic - 3D	0.14	No
WI1046-M12M4TM4T01T	Connector 3-2	M12 4-pin male D-coded Ethernet - 0° Straight	Ethernet	4	1
M12 Cab D-code Ethernet M0°-M0°, 1m, Ø6		M12 4-pin male D-coded Ethernet - 0° Straight	Standard	0.13	No
WI1046-M12M4TM4T02R	Connector 3-2	M12 4-pin male D-coded Ethernet - 0° Straight	Ethernet	4	2
M12 Cab D-code Ethernet M0°-M0°, 2,0m, Ø7		M12 4-pin male D-coded Ethernet - 0° Straight	Robotic - 3D	0.14	No
WI1046-M12M4TM4T02T	Connector 3-2	M12 4-pin male D-coded Ethernet - 0° Straight	Ethernet	4	2
M12 Cab D-code Ethernet M0°-M0°, 2,0m, Ø6		M12 4-pin male D-coded Ethernet - 0° Straight	Standard	0.13	No
WI1046-M12M4TM4T05R	Connector 3-2	M12 4-pin male D-coded Ethernet - 0° Straight	Ethernet	4	5
M12 Cab D-code Ethernet M0°-M0°, 5m, Ø7		M12 4-pin male D-coded Ethernet - 0° Straight	Robotic - 3D	0.14	No
WI1046-M12M4TM4T05T	Connector 3-2	M12 4-pin male D-coded Ethernet - 0° Straight	Ethernet	4	5
M12 Cab D-code Ethernet M0°-M0°, 5m, Ø6		M12 4-pin male D-coded Ethernet - 0° Straight	Standard	0.13	No
WI1046-M12M4TM4T10R	Connector 3-2	M12 4-pin male D-coded Ethernet - 0° Straight	Ethernet	4	10
M12 Cab D-code Ethernet M0°-M0°, 10m, Ø7		M12 4-pin male D-coded Ethernet - 0° Straight	Robotic - 3D	0.14	No
WI1046-M12M4TM4T10T	Connector 3-2	M12 4-pin male D-coded Ethernet - 0° Straight	Ethernet	4	10
M12 Cab D-code Ethernet M0°-M0°, 10m, Ø6		M12 4-pin male D-coded Ethernet - 0° Straight	Standard	0.13	No
WI1046-M12M4TM4T15R	Connector 3-2	M12 4-pin male D-coded Ethernet - 0° Straight	Ethernet	4	15
M12 Cab D-code Ethernet M0°-M0°, 15m, Ø7		M12 4-pin male D-coded Ethernet - 0° Straight	Robotic - 3D	0.14	No
WI1046-M12M4TM4T20R	Connector 3-2	M12 4-pin male D-coded Ethernet - 0° Straight	Ethernet	4	20
M12 Cab D-code Ethernet M0°-M0°, 20m, Ø7		M12 4-pin male D-coded Ethernet - 0° Straight	Robotic - 3D	0.14	No
WI1046-M12M4TM4T20T	Connector 3-2	M12 4-pin male D-coded Ethernet - 0° Straight	Ethernet	4	20
M12 Cab D-code Ethernet M0°-M0°, 20m, Ø6		M12 4-pin male D-coded Ethernet - 0° Straight	Standard	0.13	No



MIS232R3EPH466

Int.StepH 12-72VDC, Profinet, AbsC-L

Cable information

Item number	Mount on	Cable con 1 +Con 1 angle	Cable application	Wires no totally	Cable length [m]
Item description		Cable con 2 +Con 2 angle	Cable flexibility	Wire [mm2]	Connector 1 LED
WI1046-M12M4VM4T.6N M12 Cab D-code Ethernet M90°-M0°, 0,6m, Ø6	Connector 3-2	M12 4-pin male D-coded Ethernet - 90° Angled Ethernet	Standard	4	0.6
WI1046-M12M4VM4V.6N M12 Cab D-code Ethernet M90°-M90°, 0,6m, Ø6	Connector 3-2	M12 4-pin male D-coded Ethernet - 90° Angled Ethernet	Standard	4	0.6
WI1005-M12M17SAA01 M12 17-pin male Axis 1 Without wire	Connector 4	M12 17-pin male A-coded - 0° Straight n/a - n/a	n/a	n/a n/a	Connector No
WI1005-M12M17SAA01-1 M12 17-pin male Axis 1, with wire 1,2m	Connector 4	M12 17-pin male A-coded - 0° Straight n/a - n/a		n/a n/a	Connector No
WI1005-M12M17SAA02 M12 17-pin male Axis 2 Without wire	Connector 4	M12 17-pin male A-coded - 0° Straight n/a - n/a	n/a	n/a n/a	Connector No
WI1005-M12M17SAA03 M12 17-pin male Axis 3 Without wire	Connector 4	M12 17-pin male A-coded - 0° Straight n/a - n/a	n/a	n/a n/a	Connector No
WI1005-M12M17SAA04 M12 17-pin male Axis 4 Without wire	Connector 4	M12 17-pin male A-coded - 0° Straight n/a - n/a	n/a	n/a n/a	Connector No
WI1005-M12M17SAA05 M12 17-pin male Axis 5 Without wire	Connector 4	M12 17-pin male A-coded - 0° Straight n/a - n/a	n/a	n/a n/a	Connector No
WI1005-M12M17SAA06 M12 17-pin male Axis 6 Without wire	Connector 4	M12 17-pin male A-coded - 0° Straight n/a - n/a	n/a	n/a n/a	Connector No
WI1005-M12M17SAA06-1 M12 17-pin male Axis 6 with wire 1,2m	Connector 4	M12 17-pin male A-coded - 0° Straight n/a - n/a		n/a n/a	Connector No
WI1005-M12M17SAA07 M12 17-pin male Axis 7 Without wire	Connector 4	M12 17-pin male A-coded - 0° Straight n/a - n/a	n/a	n/a n/a	Connector No
WI1005-M12M17SAA08 M12 17-pin male Axis 8 Without wire	Connector 4	M12 17-pin male A-coded - 0° Straight n/a - n/a	n/a	n/a n/a	Connector No
WI1005-M12M17SAA09 M12 17-pin male Axis 9 Without wire	Connector 4	M12 17-pin male A-coded - 0° Straight n/a - n/a	n/a	n/a n/a	Connector No
WI1005-M12M17SAA10 M12 17-pin male Axis 10 Without wire	Connector 4	M12 17-pin male A-coded - 0° Straight n/a - n/a	n/a	n/a n/a	Connector No
WI1008-M12M17SR1 M12 Con 17p Male 0° Metal housing 5.4-8.2mm cable	Connector 4	M12 12-pin male A-coded - 0° Straight - n/a	n/a	n/a n/a	Connector No
WI1009-M12M17T01N M12 Shl Cable 1m 17p Mal 0° MISxx,Ex41 twisted	Connector 4	M12 17-pin male A-coded - 0° Straight Open Ended - n/a	Basic I/O, Com Standard	17 0.061	1 No
WI1009-M12M17T05N M12 Shl Cable 5m 17p Mal 0° MISxx,Ex41 twisted	Connector 4	M12 17-pin male A-coded - 0° Straight Open Ended - n/a	Basic I/O, Com Standard	17 0.061	5 No
WI1009-M12M17T10R M12 Shl Cable 10m 17p Mal 0° MISxx,Ex41 twisted	Connector 4	M12 17-pin male A-coded - 0° Straight Open Ended - n/a	Basic I/O, Com Robotic - 3D	17 0.061	5 No
WI1009-M12M17T20N M12 Shl Cable 20m 17p Mal 0° MISxx,Ex41 twisted	Connector 4	M12 17-pin male A-coded - 0° Straight Open Ended - n/a	Basic I/O, Com Standard	17 0.061	20 No
WI1009-M12M17TF17T.5 M12 Shl Cable.5m Male17p0°-Female 17p0° twist pair	Connector 4	M12 17-pin male A-coded - 0° Straight M12 17-pin female A-coded - 0° Straight	Basic I/O, Com Standard	17 0.061	0.5 No
WI1009-M12M17TF17T01 M12 Shl Cable 1m Male17p0°-Female 17p0° twist pair	Connector 4	M12 17-pin male A-coded - 0° Straight M12 17-pin female A-coded - 0° Straight	Basic I/O, Com Standard	17 0.061	1 No
WI1009-M12M17TF17T02 M12 Shl Cable 2m Male17p0°-Female 17p0° twist pair	Connector 4	M12 17-pin male A-coded - 0° Straight M12 17-pin female A-coded - 0° Straight	Basic I/O, Com Standard	17 0.061	2 No
WI1009-M12M17TF17T03 M12 Shl Cable 3m Male17p0°-Female 17p0° twist pair	Connector 4	M12 17-pin male A-coded - 0° Straight M12 17-pin female A-coded - 0° Straight	Basic I/O, Com Standard	17 0.061	3 No
WI1009-M12M17TF17T04 M12 Shl Cable 4m Male17p0°-Female 17p0° twist pair	Connector 4	M12 17-pin male A-coded - 0° Straight M12 17-pin female A-coded - 0° Straight	Basic I/O, Com Standard	17 0.061	4 No
WI1009-M12M17V05N M12 Shl Cable 5m 17p Mal 90° MISxx,Ex41 twisted	Connector 4	M12 17-pin male A-coded - 90° Angled Open Ended - n/a	Basic I/O, Com Standard	17 0.061	5 No
WI1009-M12M17V10N M12 Shl Cable 10m 17p Mal 90° MISxx,Ex41 twisted	Connector 4	M12 17-pin male A-coded - 90° Angled Open Ended - n/a	Basic I/O, Com Standard	17 0.061	10 No
RS485-M12-1-5-17 RS485 M12-17pin DSub, 5m v1.1	Connector 4 RS485	M12 17-pin male A-coded - 0° Straight D-Sub 9-pin female - RS485 - 0° Straight	Communication Cable chains - 2D	3 0.32	5 No