



## MIS231S1EPH2S6

Int.Step 12-72VDC, Profinet, EncC-L, STO

ServoStep MIS is a series of integrated stepper motors with servo control (closed-loop) and up to 3000 RPM.

It consists of NEMA 17..23..34..43 size motors with holding torques from 0.36 Nm up to 25 Nm. All motors are programmable and have 8 I/O points (each can be DI or DO or AI).

Options include:

- incremental (semi-absolute) encoder\*). absolute multiturn encoder
- brake module\*)
- radial or axial\*) connectors
- CANopen
- Ethernet interface w/built-in switch for easy daisy-chaining and all protocols (Profinet. EtherNet/IP. EtherCAT. Sercos. ModbusTCP/UDP. Powerlink).
- Wireless versions are also possible: WLAN or BlueTooth.
- Special shaft versions include double shaft and hollow shaft. contact JVL to learn which combinations are possible.
- Higher IP versions are also available. \*) Depending of other options



### General information

<b>Description</b>	Int.Step 12-72VDC, Profinet, EncC-L, STO, 4xM12. 2x4pF:Profinet 17pF:8xDIO/AI +RS422+RS485, High Resolution: 409.600 step/rev. ±0.01 RPM, Programmable (incl. current, position & velocity), with STO, Closed-Loop Semi-Abs. Encoder 4096 CPR, ø6.35x20 mm Round, Shaft: IP42, Motor: IP42, 56.4x103 mm Holding Torque: 0.97 Nm Radial Connector 12-72 VDC Mechanical Power: 177 W, Isolated from earth		
<b>Manufacture</b>	JVL	<b>Motor type</b>	Integrated Stepper - Rotating
<b>Motor resolution</b>	409600	<b>Encoder type</b>	H2 Incremental/abs_singleturn
<b>Integrated PLC</b>	Yes	<b>PLC no. of DI/DO/AI</b>	8
<b>Closed loop</b>	Yes	<b>STO connector</b>	Yes
<b>Integrated gear</b>	No	<b>Gear ratio</b>	
<b>Brake</b>	No	<b>Speed [Rpm]</b>	3000.00
<b>Connectivity: Without module</b>	Profinet	<b>Power Peak [W]</b>	177.00
<b>Flange Type Front</b>		<b>Protection House/Shaft</b>	
<b>Shaft size - Front [mm]</b>	6.35 mm		
<b>Running torque [Nm]</b>	0.97	<b>Rated Winding current [A]</b>	6.0
<b>Main supply [V]</b>	12-72	<b>Voltage type - Main</b>	DC



## MIS231S1EPH2S6

Int.Step 12-72VDC, Profinet, EncC-L, STO

### General information

<b>Control voltage (CVI/O+) [VDC]</b>	7-28	<b>Holding torque [Nm]</b>	0.97
---------------------------------------	------	----------------------------	------

<b>Shaft Double</b>	No
---------------------	----

<b>Weight net [kg]</b>	1.02	<b>MTBF 100% [Year]</b>	13
------------------------	------	-------------------------	----

<b>Weight gross [kg]</b>	1.14	<b>MTBF 30% [Year]</b>	15
--------------------------	------	------------------------	----

<b>Software</b>	MacTalk
-----------------	---------

<b>CE Marked</b>	Yes
------------------	-----



<b>Approval - ROHS-3</b>	Yes
--------------------------	-----



<b>Approval UL</b>	No
--------------------	----

<b>Tariff no</b>	85015100	<b>Country Of Origin</b>	DK
------------------	----------	--------------------------	----



## MIS231S1EPH2S6

Int.Step 12-72VDC, Profinet, EncC-L, STO

### Mechanical information

Motor Type	Length (L) ±1.0 [0.0787]	Shaft dia. (D) +0 / -0.013mm[0.000512]
MIS231S...	103 [4.06]	6.35 [0.25]
MIS232S...	124 [4.88]	6.35 [0.25]
MIS234S...	161 [6.34]	10.0 [0.3937]
MIS231T...	103 [4.06]	6.35 [0.25]
MIS232T...	124 [4.88]	10.0 [0.3937]

This drawing covers only motor type MIS23xS and MIS23xT with radial connectors

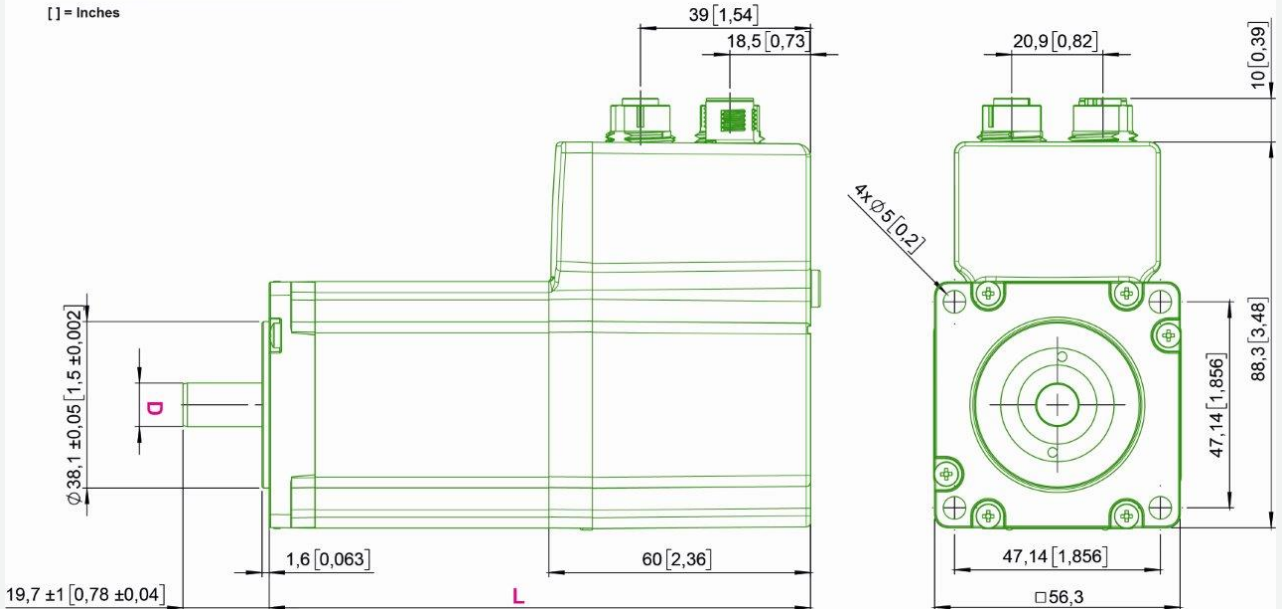

<b>Motor length [mm]</b>	103	<b>Motor width [mm]</b>	56.4
<b>Motor height [mm]</b>	88.1		
<b>Protection house</b>	IP42	<b>Protection shaft</b>	IP42
		<b>Flange Rear</b>	No
<b>Flange Type Front</b>		<b>Flange Type Rear</b>	
<b>Motor diameter center front [mm]</b>	38.1	<b>Motor diameter center rear [mm]</b>	
<b>Bolt circle diameter front [mm]</b>	66.6	<b>Bolt circle diameter front [mm]</b>	
<b>Mounting holes front [mm]</b>	5 mm	<b>Mounting holes rear [mm]</b>	
<b>Flange material</b>	Aluminium	<b>Flange Thickness [mm]</b>	
		<b>Shaft Double</b>	No
<b>Shaft Type Output</b>	Round	<b>Shaft Type Rear</b>	
<b>Shaft size - Front [mm]</b>	6.35 mm	<b>Shaft size - Rear</b>	-
<b>Shaft length Front [mm]</b>	19.5	<b>Shaft length Rear [mm]</b>	
<b>Shaft material</b>	Stainless steel AISI303		
<b>Shaft Key included</b>	Key NOT included	<b>Shaft Key Dimension</b>	-
<b>Front bearing type</b>	6000ZZ	<b>Rear bearing type</b>	6000ZZ
<b>Radial load [N]</b>	1343	<b>Radial load distance [mm]</b>	10



## MIS231S1EPH2S6

Int.Step 12-72VDC, Profinet, EncC-L, STO

### Mechanical information

<b>Axial load [N]</b>	377		
<b>Axial play [mm]</b>		<b>Axial play force [N]</b>	
<b>Integrated gear</b>	No	<b>Gear ratio</b>	
<b>Gear efficiency [%]</b>	-	<b>Gear backlash [ArcMin]</b>	-
<b>Brake</b>	No	<b>Brake - Go ON time [ms]</b>	-
<b>Brake Holding torque [Nm]</b>	-	<b>Brake - Go OFF time [ms]</b>	-
<b>Rotor inertia [kgcm<sup>2</sup>]</b>	0.3	<b>Max inertia factor</b>	40
<b>Precision Motor - Absolute [Deg]</b>	0.35	<b>Precision Motor - Max Load [Deg]</b>	
<b>Precision Motor - Repeatability [Deg]</b>	0.15	<b>Step angle [°/full step]</b>	1.8°
<b>2D [PDF]</b>	Download	<b>2D [DWG]</b>	No
<b>3D [DWG]</b>	No	<b>3D [EASM]</b>	Download
<b>3D [IGES]</b>	No	<b>3D [STEP]</b>	Download
<b>Datasheet - pdf</b>		<b>CAD file page</b>	Link
<b>User Manual</b>	Download	<b>WEB page</b>	Link
<b>Approval UL</b>	No	<b>STO connector</b>	Yes
<b>Approval - ATEX</b>	No	<b>Approval TÜV - STO</b>	Yes
<b>Oil resistant</b>			
<b>Temperature ambient [°C]</b>	0...40 °C and 0...70 °C with derating of performance		
<b>Temperature storage</b>	-40...70 °C		
<b>Humidity working</b>	5...93% non-condensing		
<b>Vibration</b>	5-25 Hz: +/-1.6mm, 25-500Hz: 4G, 1.0 oct./min		
<b>Shock</b>	15G, 30ms. 6 x 1000 cycles in +/-X, +/-Y, +/-Z		
<b>Withstand Voltage</b>	500 VDC between earth and supply ground		
<b>EMC in general</b>	EMC Directive DIR2014/30/EU		
<b>EMC Emission</b>	EN61800-3 / EN61000-6-3 / EN61000-6-4 all 2. environment		
<b>EMC Immunity</b>	En IEC 61800-3 / EN61000-6-1 all 2. environment		
<b>Safety in general</b>	LVD DIR2014/35/EU / EL61800 - USA and Canada only MIS34x products are pending		
<b>Safety wo STO</b>	EN60950-1		
<b>Safety w STO</b>	EN60950-1 / EN61508-1/-2 SIL3 / ISO13849-1/-2 / ISO62061 / EN61800-5-1/-2		
<b>Inviromental</b>	IEC 60068-2-27, Test Ea. Shock test		
	IEC 60068-2-6, Test Fc. Vibration test		
	IEC 60068-2-2, Test Bd. covers temperaturerise/dry heat		
	IEC 60068-2-78, Perm. moisture/Damp heat, steady state		
<b>REACH SVHC document</b>			
<b>Low voltage Directive</b>			
<b>No Dual Use</b>			



**MIS231S1EPH2S6**

Int.Step 12-72VDC, Profinet, EncC-L, STO

**Mechanical information**

<b>Duty Cycle</b>		<b>Max Duty Cycle [%]</b>	
<b>Axial Load Typical [N]</b>	377	<b>Axial Load Long [N]</b>	314

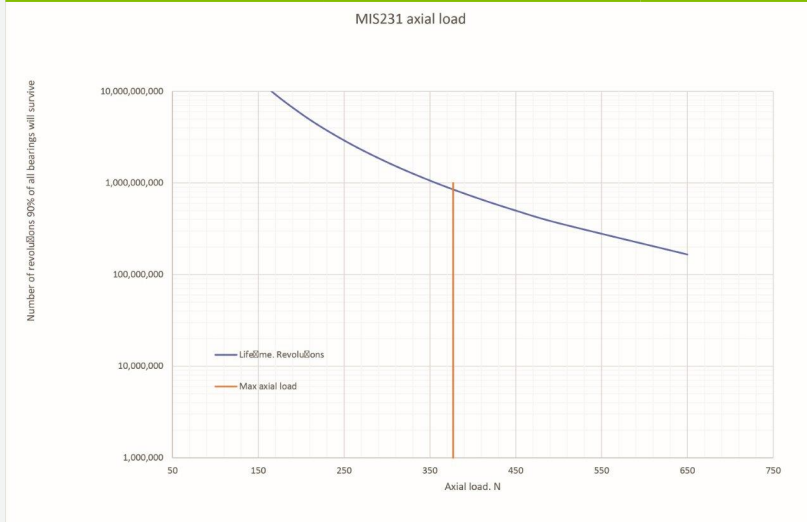

<b>Radial Load Typical [N]</b>	346	<b>Radial Load Long [N]</b>	282
--------------------------------	-----	-----------------------------	-----

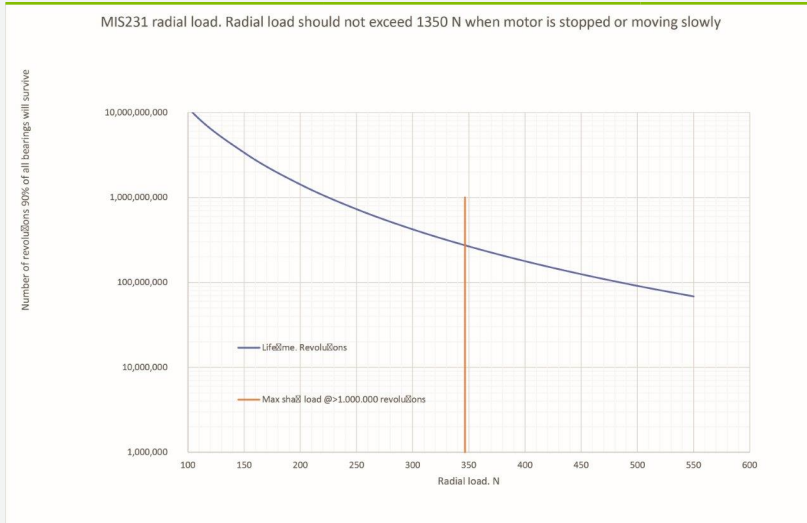

<b>Load typical term</b>		<b>Load Long term</b>	
<b>Shaft Seal</b>			



## MIS231S1EPH2S6

Int.Step 12-72VDC, Profinet, EncC-L, STO

### Connector information

<b>Connector 1 label</b>	PWR	<b>Connector 1</b>	M12 5-pin male A-coded
<b>Connector 2 label</b>	CN2	<b>Connector 2</b>	M12 4-pin female D-coded Ethernet
<b>Connector 3 label</b>	CN3	<b>Connector 3</b>	M12 4-pin female D-coded Ethernet
<b>Connector 4 label</b>	CN4	<b>Connector 4</b>	M12 17-pin female A-coded
<b>Connector 1 RS485</b>	No	<b>Connector 2 RS485</b>	No
<b>Connector 3 RS485</b>	No	<b>Connector 4 RS485</b>	Yes

### Motor connectors

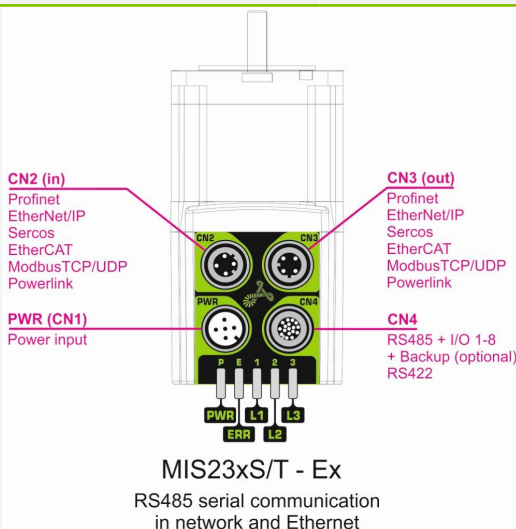

#### Picture CN1

"PWR" (CN1) - Power input. M12 - 5pin male connector				
Signal name	Description	Pin no.	JVL Cable W11000-M12F5TxxN	Isolation group
P+	Main supply +7-72VDC. Connect with pin 2 *	1	Brown	1
P+	Main supply +7-72VDC. Connect with pin 1 *	2	White	1
P-	Main supply ground. Connect with pin 5 *	3	Blue	1
CVI	Control and user output supply +7-30VDC. <b>DO NOT connect &gt;30V to this terminal!</b>	4	Black	1
P-	Main supply ground. Connect with pin 3 *	5	Grey	1

\* Note: P+ and P- are each available at 2 terminals. Make sure that both terminals are connected in order to split the supply current in 2 terminals and thereby avoid an overload of the connector.

#### Picture CN2

"CN2" - Ethernet In port connector - M12 - 4pin female connector "D" coded				
Signal name	Description	Pin no.	JVL Cable W11046-M12M4S05R	Isolation group (See note)
Tx0_P	Ethernet Transmit channel 0 - positive terminal	1	-	2
Rx0_P	Ethernet Receive channel 0 - positive terminal	2	-	2
Tx0_N	Ethernet Transmit channel 0 - negative terminal	3	-	2
Rx0_N	Ethernet Receive channel 0 - negative terminal	4	-	2



**MIS231S1EPH2S6**

Int.Step 12-72VDC, Profinet, EncC-L, STO

**Connector information**

**Picture CN3**

**“CN3” - Ethernet Out port connector. M12 - 4 pin female connector “D” coded**

Signal name	Description	Pin no.	JVL Cable WI1046- M12M4S05R	Isolation group (see note)
Tx1_P	Ethernet Transmit channel 1 - positive terminal	1	-	3
Rx1_P	Ethernet Receive channel 1 - positive terminal	2	-	3
Tx1_N	Ethernet Transmit channel 1 - negative terminal	3	-	3
Rx1_N	Ethernet Receive channel 1 - negative terminal	4	-	3

**Picture CN4**

**“CN4” - RS485 + I/O + Backup (option) connector - M12 - 17pin female connector**

Signal name	Description	Pin no.	JVL Cable WI1009M12 M17TxxN	Isolation group (see note)
IO1	I/O channel 1. Can be used as input or output	1	Brown	1
GND	Ground intended to be used together with the other signals in this connector	2	Blue	1
IO2	I/O channel 2. Can be used as input or output	3	White	1
IO3	I/O channel 3. Can be used as input or output	4	Green	1
RS422: B1-	RS422 I/O terminal B-	5	Pink	1
IO4	I/O channel 4. Can be used as input or output	6	Yellow	1
RS422: A1-	RS422 I/O terminal A-	7	Black	1
RS422: B1+	RS422 I/O terminal B+	8	Grey	1
CVO	Supply output. Connected internally to the CVI terminal in the PWR connector. <b>DO NOT connect &gt;30V to this terminal!</b>	9	Red	1
RS422: A1+	RS422 I/O terminal A+	10	Violet	1
IO5	I/O channel 5. Can be used as input or output	11	Grey/pink	1
IO6	I/O channel 6. Can be used as input or output	12	Red/blue	1
IO7	I/O channel 7. Can be used as input or output	13	White/Green	1
IO8	I/O channel 8. Can be used as input or output	14	Brown/Green	1
RS485: B0-	RS485 interface. Leave open if unused	15	White/Yellow	1
EXTBACKUP	Only for motors with the -H3 or -H4 option (abs. multiturn encoder). This terminal can be connected to an external supply. <b>Connect to ground (GND) if not used.</b>	16	Yellow/brown	1
RS485: A0+	RS485 interface. Leave open if unused	17	White/grey	1

\* Note: Isolation group indicate which terminals/circuits that a galvanic connected to each other. In other words group 1, 2, 3 and 4 are all fully independently isolated from each other. Group 1 correspond to the housing of the motor which may also be connected to earth via the DC or AC input supply.

**Connector STO**

M8 4-pin female A-coded

**Picture STO Con**

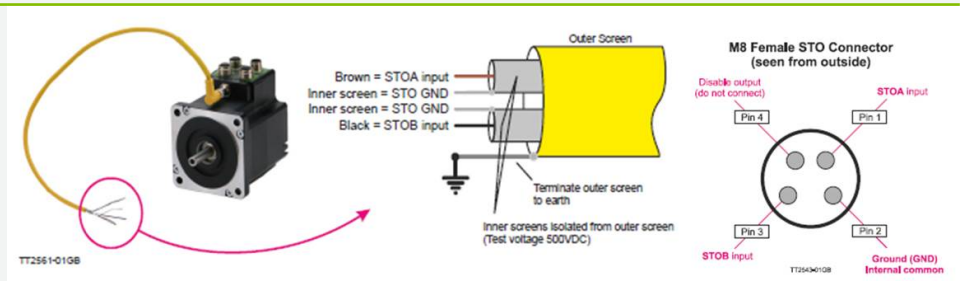



## MIS231S1EPH2S6

Int.Step 12-72VDC, Profinet, EncC-L, STO

### Torque, force and Power information

<b>Supply Volt 1 [V]</b>		<b>Power Peak 1 [W]</b>	
<b>Supply Volt 2 [V]</b>	24	<b>Power Peak 2 [W]</b>	69.00
<b>Supply Volt 3 [V]</b>	48	<b>Power Peak 3 [W]</b>	137.00
<b>Supply Volt 4 [V]</b>	72	<b>Power Peak 4 [W]</b>	177.00
<b>Holding torque [Nm]</b>	0.97	<b>Running torque [Nm]</b>	0.97
<b>Detent torque [Nm]</b>			

### MIS231S motor torque and shaft power versus speed

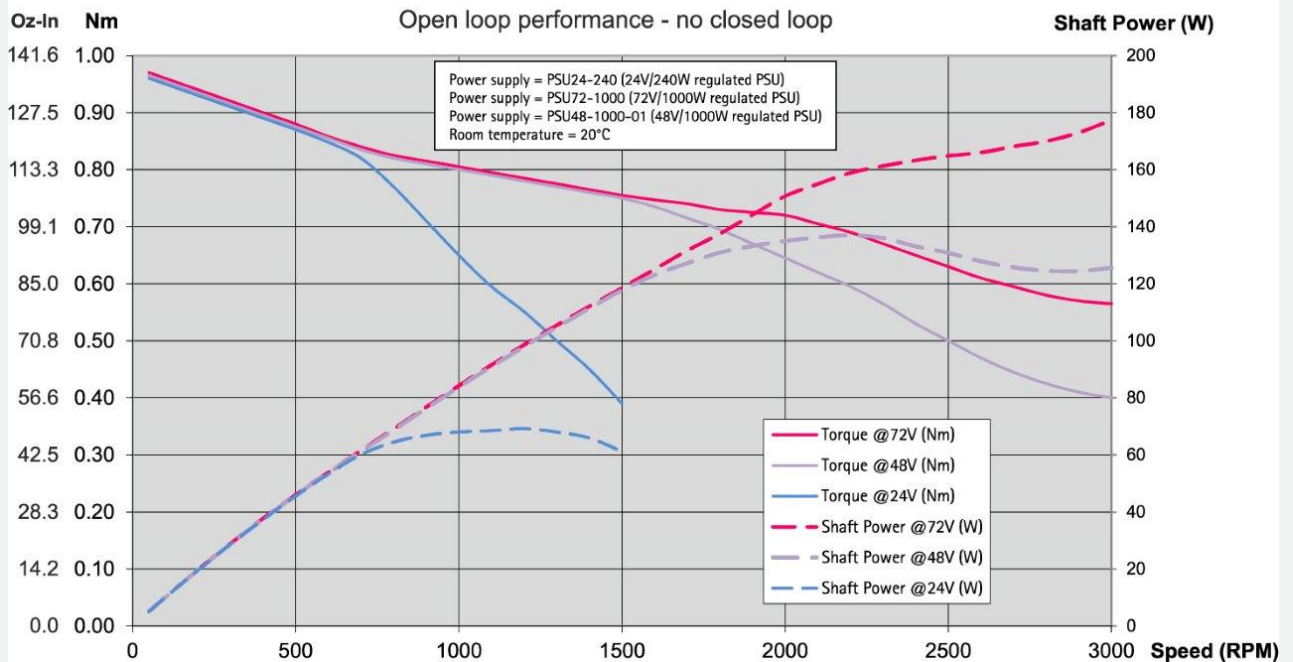





**MIS231S1EPH2S6**

Int.Step 12-72VDC, Profinet, EncC-L, STO

**Electrical information**

<b>Main supply [V]</b>	12-72	<b>Main supply Min-Max [V]</b>	7-90
<b>Rated motor current [A]</b>	5.2		
<b>Control voltage (CVI/O+) [VDC]</b>	7-28	<b>Control Voltage (CVI) Min-Max [VDC]</b>	7-30
<b>CVI current wo Ethernet and output (12/24VDC) [mA]</b>	90/55	<b>Current Ethernet option (12/24VDC) [mA]</b>	120/60
<b>Current brake option [mA]</b>	-	<b>Current for 1 Dig. output - max [mA]</b>	350
<b>Max current CVI [A]</b>			
<b>Dig. Input impedans</b>	30 Kohm	<b>Counter frequency max</b>	12MHz
<b>MTBF 30% [Year]</b>	15	<b>MTBF 100% [Year]</b>	13
<b>Motor resolution</b>	409600	<b>Encoder type</b>	H2 Incremental/abs_singleturn
<b>Encoder Resolution (H2)</b> H2 - 4096 Singleturn AbsEnc - Semi multiturn			
<b>Encoder Resolution (H3)</b>	-	<b>Encoder revolutions</b>	+/-5242
<b>PLC no. of DI/DO/AI</b>	8	<b>Analogue voltage</b>	0-5VDC 12bit
<b>Standard used</b>		<b>Standard used 2</b>	
<b>Resistance [Ohm]</b>		<b>Induction [mH]</b>	



**MIS231S1EPH2S6**

Int.Step 12-72VDC, Profinet, EncC-L, STO

**Communication information**

<b>Software</b>	MacTalk	<b>Connector 2 RS485</b>	No
<b>Connectivity: Without module</b>	Profinet	<b>Connector 3 RS485</b>	No
		<b>Connector 4 RS485</b>	Yes

**Motor connectors**

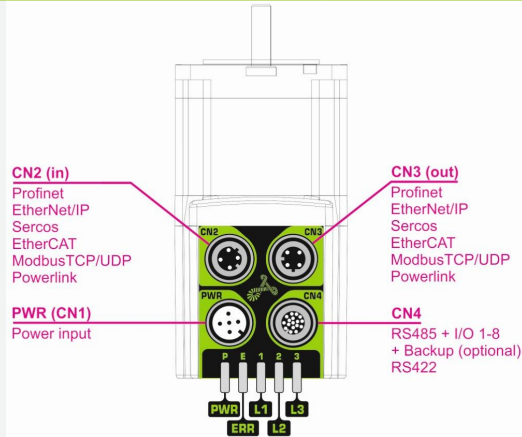

MIS23xS/T - Ex  
RS485 serial communication  
in network and Ethernet

**e-PLC Files**

**Ethernet, PLC demo files**



## MIS231S1EPH2S6

Int.Step 12-72VDC, Profinet, EncC-L, STO

### Cable information

Item number	Mount on	Cable con 1 +Con 1 angle	Cable application	Wires no totally	Cable length [m]
Item description		Cable con 2 +Con 2 angle	Cable flexibility	Wire [mm2]	Connector 1 LED
WI1000-M12F5T02N	Connector 1	M12 5-pin female A-coded - 0° Straight	Power/Motor/com	5	2
M12 Shl Cable 2m 5 pin Fem 0°, Power		Open Ended - n/a	Standard	0.32	No
WI1000-M12F5T05N	Connector 1	M12 5-pin female A-coded - 0° Straight	Power/Motor/com	5	5
M12 Shl Cable 5m 5 pin Fem 0°, Power		Open Ended - n/a	Standard	0.32	No
WI1000-M12F5T1.2N	Connector 1	M12 5-pin female A-coded - 0° Straight	Power/Motor/com	5	1.2
M12 Shl Cable 1.2m 5 pin Fem 0°, Power		Open Ended - n/a	Standard	0.32	No
WI1000-M12F5T10N	Connector 1	M12 5-pin female A-coded - 0° Straight	Power/Motor/com	5	10
M12 Shl Cable 10m 5 pin Fem 0°, Power		Open Ended - n/a	Standard	0.32	No
WI1000-M12F5T10R	Connector 1	M12 5-pin female A-coded - 0° Straight	Power/Motor/com	5	10
M12 Shl Cable 10m 5 pin Fem 0°, Power, High-flex		Open Ended - n/a	Robotic - 3D	0.32	No
WI1000-M12F5T20N	Connector 1	M12 5-pin female A-coded - 0° Straight	Power/Motor/com	5	20
M12 Shl Cable 20m 5 pin Fem 0°, Power		Open Ended - n/a	Standard	0.32	No
WI1000-M12F5TLT0185	Connector 1	M12 5-pin female A-coded - 0° Straight	Power	5	3
M12 shl Cable 3m 5 pin female 0°,PW SPEC		- n/a	Standard	0.32	No
WI1000-M12F5V05N	Connector 1	M12 5-pin female A-coded - 90° Angled	Power/Motor/com	5	5
M12 Shl Cable 5m 5 pin Fem 90°, Power		Open Ended - n/a	Standard	0.32	No
WI1000-M12F5V10N	Connector 1	M12 5-pin female A-coded - 90° Angled	Power/Motor/com	5	10
M12 Shl Cable 10 m 5 pin Fem 90°, Power		Open Ended - n/a	Standard	0.32	No
WI1000-M12F5V20N	Connector 1	M12 5-pin female A-coded - 90° Angled	Power/Motor/com	5	20
M12 Shl Cable 20m 5 pin Fem 90°, Power		Open Ended - n/a	Standard	0.32	No
WI1000-M12F5W05N	Connector 1	M12 5-pin female A-coded - 90° Angled	Power 24/48	5	5
M12 Shl Cable 5m LED 5p Fem 90°, Power <50V		Open Ended - n/a	Standard	0.32	LED
WI1000-M12F5W10N	Connector 1	M12 5-pin female A-coded - 90° Angled	Power 24/48	5	10
M12 Shl Cable 10m LED 5 p Fem 90°, Power <50V		Open Ended - n/a	Standard	0.32	LED
WI1000-M12F5W15N	Connector 1	M12 5-pin female A-coded - 90° Angled	Power 24/48	5	15
M12 Shl Cable 15m LED 5 p Fem 90°, Power <50V		Open Ended - n/a	Standard	0.32	LED
WI1000-M12F5W20N	Connector 1	M12 5-pin female A-coded - 90° Angled	Power 24/48	5	20
M12 Shl Cable 20m LED 5 p Fem 90°, Power <50V		Open Ended - n/a	Standard	0.32	LED
WI1000-M12F5WF5W20N	Connector 1	M12 5-pin female A-coded - 90° Angled	Power 24/48	5	20
M12 shl cab 20m LED 5 pin female 90',Pow <50V		M12 5-pin female A-coded - 90° Angled	Standard	0.32	LED
WI1008-M12F5SS1	Connector 1	M12 5-pin female A-coded - 0° Straight		n/a	Connector
M12 Con 5p Fem 0° Solder assembly		- n/a	n/a	n/a	No
WI1008-M12F5TG1	Connector 1	M12 5-pin female A-coded - 0° Straight		n/a	Connector
M12 Con 5p Fem 0° Spring Shield+B222		- n/a	n/a	n/a	No
WI1008-M12F5VG1	Connector 1	M12 5-pin female A-coded - 90° Angled		n/a	Connector
M12 Con 5p Fem 90° Spring Shield		- n/a	n/a	n/a	No
WI1046-M12M4S.3NRJ45	Connector 2	M12 4-pin male D-coded Ethernet - 0° Straight	Ethernet	4	0.3
M12 Cab D-code Ethernet M0°-RJ45, 0.3m, Ø5		RJ45 male - 0° Straight	Standard	0.13	No
WI1046-M12M4S01NRJ45	Connector 2	M12 4-pin male D-coded Ethernet - 0° Straight	Ethernet	4	1
M12 Cab D-code Ethernet M0°-RJ45, 1.0m, Ø5		RJ45 male - 0° Straight	Standard	0.13	No
WI1046-M12M4S05NRJ45	Connector 2	M12 4-pin male D-coded Ethernet - 0° Straight	Ethernet	4	5
M12 Cab D-code Ethernet M0°-RJ45, SFTP, 5m, Ø5		RJ45 male - 0° Straight	Standard	0.13	No
WI1046-M12M4S05R	Connector 2	M12 4-pin male D-coded Ethernet - 0° Straight	Ethernet	4	5
M12 Cab D-code Ethernet M0°, SFTP, 5m Ø7		Open Ended - n/a	Cable chains - 2D	0.13	No
WI1046-M12M4S10NRJ45	Connector 2	M12 4-pin male D-coded Ethernet - 0° Straight	Ethernet	4	10
M12 Cab D-code Ethernet M0°-RJ45, 10m, Ø5		RJ45 male - 0° Straight	Standard	0.13	No
WI1046-M12M4S15NRJ45	Connector 2	M12 4-pin male D-coded Ethernet - 0° Straight	Ethernet	4	15
M12 Cab D-code Ethernet M0°-RJ45, 15m, RJ45 Ø5		RJ45 male - 0° Straight	Standard	0.13	No
WI1046-M12M4S15R	Connector 2	M12 4-pin male D-coded Ethernet - 0° Straight	Ethernet	4	15
M12 Cab D-code Ethernet M0°, 15m Ø7		Open Ended - n/a	Cable chains - 2D	0.13	No
WI1046-M12M4T.3TRJ45	Connector 2	M12 4-pin male D-coded Ethernet - 0° Straight	Ethernet	4	0.3
M12 Cab D-code Ethernet M0°-RJ45, 0.3m, RJ45 Ø5		RJ45 male - 0° Straight	Standard	0.13	No
WI1046-M12M4T01TRJ45	Connector 2	M12 4-pin male D-coded Ethernet - 0° Straight	Ethernet	4	1
M12 Cab D-code Ethernet M0°-RJ45, 1m, RJ45 Ø5		RJ45 male - 0° Straight	Standard	0.13	No
WI1046-M12M4T02NRJ45	Connector 2	M12 4-pin male D-coded Ethernet - 0° Straight	Ethernet	4	2



## MIS231S1EPH2S6

Int.Step 12-72VDC, Profinet, EncC-L, STO

### Cable information

Item number	Mount on	Cable con 1 +Con 1 angle	Cable application	Wires no totally	Cable length [m]
Item description		Cable con 2 +Con 2 angle	Cable flexibility	Wire [mm2]	Connector 1 LED
M12 Cab D-code Ethernet M0°-RJ45, 2m, Ø5		RJ45 male - 0° Straight	Standard	0.13	No
WI1046-M12M4T05TRJ45	Connector 2	M12 4-pin male D-coded Ethernet - 0° Straight	Ethernet	4	5
M12 Cab D-code Ethernet M0°-RJ45, 5m, Ø5		RJ45 male - 0° Straight	Standard	0.13	No
WI1046-M12M4T10TRJ45	Connector 2	M12 4-pin male D-coded Ethernet - 0° Straight	Ethernet	4	10
M12 Cab D-code Ethernet M0°-RJ45, 10m, Ø5		RJ45 male - 0° Straight	Standard	0.13	No
WI1046-M12M4T15TRJ45	Connector 2	M12 4-pin male D-coded Ethernet - 0° Straight	Ethernet	4	15
M12 Cab D-code Ethernet M0°-RJ45, SFTP, 15m, Ø5		RJ45 male - 0° Straight	Standard	0.13	No
WI1046-M12M4T20TRJ45	Connector 2	M12 4-pin male D-coded Ethernet - 0° Straight	Ethernet	4	20
M12 Cab D-code Ethernet M0°-RJ45, 20m, Ø5		RJ45 male - 0° Straight	Standard	0.13	No
WI1046-M12M4TM4T.3R	Connector 2	M12 4-pin male D-coded Ethernet - 0° Straight	Ethernet	4	0.3
M12 Cab D-code Ethernet M0°-M0°, 0,3m, Ø6		M12 4-pin male D-coded Ethernet - 0° Straight	Robotic - 3D	0.14	No
WI1046-M12M4TM4T.3T	Connector 2	M12 4-pin male D-coded Ethernet - 0° Straight	Ethernet	4	0.3
M12 Cab D-code Ethernet M0°-M0°, 0,3m, Ø6		M12 4-pin male D-coded Ethernet - 0° Straight	Standard	0.13	No
WI1046-M12M4TM4T01R	Connector 2	M12 4-pin male D-coded Ethernet - 0° Straight	Ethernet	4	1
M12 Cab D-code Ethernet M0°-M0°, 1m, Ø7		M12 4-pin male D-coded Ethernet - 0° Straight	Robotic - 3D	0.14	No
WI1046-M12M4TM4T01T	Connector 2	M12 4-pin male D-coded Ethernet - 0° Straight	Ethernet	4	1
M12 Cab D-code Ethernet M0°-M0°, 1m, Ø6		M12 4-pin male D-coded Ethernet - 0° Straight	Standard	0.13	No
WI1046-M12M4TM4T02R	Connector 2	M12 4-pin male D-coded Ethernet - 0° Straight	Ethernet	4	2
M12 Cab D-code Ethernet M0°-M0°, 2,0m, Ø7		M12 4-pin male D-coded Ethernet - 0° Straight	Robotic - 3D	0.14	No
WI1046-M12M4TM4T02T	Connector 2	M12 4-pin male D-coded Ethernet - 0° Straight	Ethernet	4	2
M12 Cab D-code Ethernet M0°-M0°, 2,0m, Ø6		M12 4-pin male D-coded Ethernet - 0° Straight	Standard	0.13	No
WI1046-M12M4TM4T05R	Connector 2	M12 4-pin male D-coded Ethernet - 0° Straight	Ethernet	4	5
M12 Cab D-code Ethernet M0°-M0°, 5m, Ø7		M12 4-pin male D-coded Ethernet - 0° Straight	Robotic - 3D	0.14	No
WI1046-M12M4TM4T05T	Connector 2	M12 4-pin male D-coded Ethernet - 0° Straight	Ethernet	4	5
M12 Cab D-code Ethernet M0°-M0°, 5m, Ø6		M12 4-pin male D-coded Ethernet - 0° Straight	Standard	0.13	No
WI1046-M12M4TM4T10R	Connector 2	M12 4-pin male D-coded Ethernet - 0° Straight	Ethernet	4	10
M12 Cab D-code Ethernet M0°-M0°, 10m, Ø7		M12 4-pin male D-coded Ethernet - 0° Straight	Robotic - 3D	0.14	No
WI1046-M12M4TM4T10T	Connector 2	M12 4-pin male D-coded Ethernet - 0° Straight	Ethernet	4	10
M12 Cab D-code Ethernet M0°-M0°, 10m, Ø6		M12 4-pin male D-coded Ethernet - 0° Straight	Standard	0.13	No
WI1046-M12M4TM4T15R	Connector 2	M12 4-pin male D-coded Ethernet - 0° Straight	Ethernet	4	15
M12 Cab D-code Ethernet M0°-M0°, 15m, Ø7		M12 4-pin male D-coded Ethernet - 0° Straight	Robotic - 3D	0.14	No
WI1046-M12M4TM4T20R	Connector 2	M12 4-pin male D-coded Ethernet - 0° Straight	Ethernet	4	20
M12 Cab D-code Ethernet M0°-M0°, 20m, Ø7		M12 4-pin male D-coded Ethernet - 0° Straight	Robotic - 3D	0.14	No
WI1046-M12M4TM4T20T	Connector 2	M12 4-pin male D-coded Ethernet - 0° Straight	Ethernet	4	20
M12 Cab D-code Ethernet M0°-M0°, 20m, Ø6		M12 4-pin male D-coded Ethernet - 0° Straight	Standard	0.13	No
WI1046-M12M4V02TRJ45	Connector 2	M12 4-pin male D-coded Ethernet - 90° Angled	Ethernet	4	2
M12 Cab D-code Ethernet M90°-RJ45, 2m, Ø5		RJ45 male - 0° Straight	Standard	0.13	No
WI1046-M12M4V05TRJ45	Connector 2	M12 4-pin male D-coded Ethernet - 90° Angled	Ethernet	4	5
M12 Cab D-code Ethernet M90°-RJ45, 5m, Ø6		RJ45 male - 0° Straight	Standard	0.13	No
WI1046-M12M4VM4T.6N	Connector 2	M12 4-pin male D-coded Ethernet - 90° Angled	Ethernet	4	0.6
M12 Cab D-code Ethernet M90°-M0°, 0,6m, Ø6		M12 4-pin male D-coded Ethernet - 0° Straight	Standard	0.13	No
WI1046-M12M4VM4V.6N	Connector 2	M12 4-pin male D-coded Ethernet - 90° Angled	Ethernet	4	0.6
M12 Cab D-code Ethernet M90°-M90°, 0,6m, Ø6		M12 4-pin male D-coded Ethernet - 90° Angled	Standard	0.13	No
WI1048-M12M4TTR1	Connector 2	M12 4-pin male D-coded Ethernet - 0° Straight	Ethernet		Connector
M12 Con 4 p Male D Code Ethernet PressLock		- n/a	n/a		No
WI1046-M12M4TM4T.3R	Connector 2-2	M12 4-pin male D-coded Ethernet - 0° Straight	Ethernet	4	0.3
M12 Cab D-code Ethernet M0°-M0°, 0,3m, Ø6		M12 4-pin male D-coded Ethernet - 0° Straight	Robotic - 3D	0.14	No
WI1046-M12M4TM4T.3T	Connector 2-2	M12 4-pin male D-coded Ethernet - 0° Straight	Ethernet	4	0.3
M12 Cab D-code Ethernet M0°-M0°, 0,3m, Ø6		M12 4-pin male D-coded Ethernet - 0° Straight	Standard	0.13	No
WI1046-M12M4TM4T01R	Connector 2-2	M12 4-pin male D-coded Ethernet - 0° Straight	Ethernet	4	1
M12 Cab D-code Ethernet M0°-M0°, 1m, Ø7		M12 4-pin male D-coded Ethernet - 0° Straight	Robotic - 3D	0.14	No
WI1046-M12M4TM4T01T	Connector 2-2	M12 4-pin male D-coded Ethernet - 0° Straight	Ethernet	4	1
M12 Cab D-code Ethernet M0°-M0°, 1m, Ø6		M12 4-pin male D-coded Ethernet - 0° Straight	Standard	0.13	No
WI1046-M12M4TM4T02R	Connector 2-2	M12 4-pin male D-coded Ethernet - 0° Straight	Ethernet	4	2
M12 Cab D-code Ethernet M0°-M0°, 2,0m, Ø7		M12 4-pin male D-coded Ethernet - 0° Straight	Robotic - 3D	0.14	No



## MIS231S1EPH2S6

Int.Step 12-72VDC, Profinet, EncC-L, STO

### Cable information

Item number	Mount on	Cable con 1 +Con 1 angle	Cable application	Wires no totally	Cable length [m]
Item description		Cable con 2 +Con 2 angle	Cable flexibility	Wire [mm2]	Connector 1 LED
WI1046-M12M4TM4T02T	Connector 2-2	M12 4-pin male D-coded Ethernet - 0° Straight	Ethernet	4	2
M12 Cab D-code Ethernet M0°-M0°, 2,0m, Ø6		M12 4-pin male D-coded Ethernet - 0° Straight	Standard	0.13	No
WI1046-M12M4TM4T05R	Connector 2-2	M12 4-pin male D-coded Ethernet - 0° Straight	Ethernet	4	5
M12 Cab D-code Ethernet M0°-M0°, 5m, Ø7		M12 4-pin male D-coded Ethernet - 0° Straight	Robotic - 3D	0.14	No
WI1046-M12M4TM4T05T	Connector 2-2	M12 4-pin male D-coded Ethernet - 0° Straight	Ethernet	4	5
M12 Cab D-code Ethernet M0°-M0°, 5m, Ø6		M12 4-pin male D-coded Ethernet - 0° Straight	Standard	0.13	No
WI1046-M12M4TM4T10R	Connector 2-2	M12 4-pin male D-coded Ethernet - 0° Straight	Ethernet	4	10
M12 Cab D-code Ethernet M0°-M0°, 10m, Ø7		M12 4-pin male D-coded Ethernet - 0° Straight	Robotic - 3D	0.14	No
WI1046-M12M4TM4T10T	Connector 2-2	M12 4-pin male D-coded Ethernet - 0° Straight	Ethernet	4	10
M12 Cab D-code Ethernet M0°-M0°, 10m, Ø6		M12 4-pin male D-coded Ethernet - 0° Straight	Standard	0.13	No
WI1046-M12M4TM4T15R	Connector 2-2	M12 4-pin male D-coded Ethernet - 0° Straight	Ethernet	4	15
M12 Cab D-code Ethernet M0°-M0°, 15m, Ø7		M12 4-pin male D-coded Ethernet - 0° Straight	Robotic - 3D	0.14	No
WI1046-M12M4TM4T20R	Connector 2-2	M12 4-pin male D-coded Ethernet - 0° Straight	Ethernet	4	20
M12 Cab D-code Ethernet M0°-M0°, 20m, Ø7		M12 4-pin male D-coded Ethernet - 0° Straight	Robotic - 3D	0.14	No
WI1046-M12M4TM4T20T	Connector 2-2	M12 4-pin male D-coded Ethernet - 0° Straight	Ethernet	4	20
M12 Cab D-code Ethernet M0°-M0°, 20m, Ø6		M12 4-pin male D-coded Ethernet - 0° Straight	Standard	0.13	No
WI1046-M12M4VM4T.6N	Connector 2-2	M12 4-pin male D-coded Ethernet - 90° Angled	Ethernet	4	0.6
M12 Cab D-code Ethernet M90°-M0°, 0,6m, Ø6		M12 4-pin male D-coded Ethernet - 0° Straight	Standard	0.13	No
WI1046-M12M4VM4V.6N	Connector 2-2	M12 4-pin male D-coded Ethernet - 90° Angled	Ethernet	4	0.6
M12 Cab D-code Ethernet M90°-M90°, 0,6m, Ø6		M12 4-pin male D-coded Ethernet - 90° Angled	Standard	0.13	No
WI1046-M12M4S.3NRJ45	Connector 3	M12 4-pin male D-coded Ethernet - 0° Straight	Ethernet	4	0.3
M12 Cab D-code Ethernet M0°-RJ45, 0,3m, Ø5		RJ45 male - 0° Straight	Standard	0.13	No
WI1046-M12M4S01NRJ45	Connector 3	M12 4-pin male D-coded Ethernet - 0° Straight	Ethernet	4	1
M12 Cab D-code Ethernet M0°-RJ45, 1,0m, Ø5		RJ45 male - 0° Straight	Standard	0.13	No
WI1046-M12M4S05NRJ45	Connector 3	M12 4-pin male D-coded Ethernet - 0° Straight	Ethernet	4	5
M12 Cab D-code Ethernet M0°-RJ45, SFTP, 5m, Ø5		RJ45 male - 0° Straight	Standard	0.13	No
WI1046-M12M4S05R	Connector 3	M12 4-pin male D-coded Ethernet - 0° Straight	Ethernet	4	5
M12 Cab D-code Ethernet M0°, SFTP, 5m Ø7		Open Ended - n/a	Cable chains - 2D	0.13	No
WI1046-M12M4S10NRJ45	Connector 3	M12 4-pin male D-coded Ethernet - 0° Straight	Ethernet	4	10
M12 Cab D-code Ethernet M0°-RJ45, 10m, Ø5		RJ45 male - 0° Straight	Standard	0.13	No
WI1046-M12M4S15NRJ45	Connector 3	M12 4-pin male D-coded Ethernet - 0° Straight	Ethernet	4	15
M12 Cab D-code Ethernet M0°-RJ45, 15m, RJ45 Ø5		RJ45 male - 0° Straight	Standard	0.13	No
WI1046-M12M4S15R	Connector 3	M12 4-pin male D-coded Ethernet - 0° Straight	Ethernet	4	15
M12 Cab D-code Ethernet M0°, 15m Ø7		Open Ended - n/a	Cable chains - 2D	0.13	No
WI1046-M12M4T.3TRJ45	Connector 3	M12 4-pin male D-coded Ethernet - 0° Straight	Ethernet	4	0.3
M12 Cab D-code Ethernet M0°-RJ45, 0,3m, RJ45 Ø5		RJ45 male - 0° Straight	Standard	0.13	No
WI1046-M12M4T01TRJ45	Connector 3	M12 4-pin male D-coded Ethernet - 0° Straight	Ethernet	4	1
M12 Cab D-code Ethernet M0°-RJ45, 1m, RJ45 Ø5		RJ45 male - 0° Straight	Standard	0.13	No
WI1046-M12M4T02NRJ45	Connector 3	M12 4-pin male D-coded Ethernet - 0° Straight	Ethernet	4	2
M12 Cab D-code Ethernet M0°-RJ45, 2m, Ø5		RJ45 male - 0° Straight	Standard	0.13	No
WI1046-M12M4T05TRJ45	Connector 3	M12 4-pin male D-coded Ethernet - 0° Straight	Ethernet	4	5
M12 Cab D-code Ethernet M0°-RJ45, 5m, Ø5		RJ45 male - 0° Straight	Standard	0.13	No
WI1046-M12M4T10TRJ45	Connector 3	M12 4-pin male D-coded Ethernet - 0° Straight	Ethernet	4	10
M12 Cab D-code Ethernet M0°-RJ45, 10m, Ø5		RJ45 male - 0° Straight	Standard	0.13	No
WI1046-M12M4T15TRJ45	Connector 3	M12 4-pin male D-coded Ethernet - 0° Straight	Ethernet	4	15
M12 Cab D-code Ethernet M0°-RJ45, SFTP, 15m, Ø5		RJ45 male - 0° Straight	Standard	0.13	No
WI1046-M12M4T20TRJ45	Connector 3	M12 4-pin male D-coded Ethernet - 0° Straight	Ethernet	4	20
M12 Cab D-code Ethernet M0°-RJ45, 20m, Ø5		RJ45 male - 0° Straight	Standard	0.13	No
WI1046-M12M4TM4T.3R	Connector 3	M12 4-pin male D-coded Ethernet - 0° Straight	Ethernet	4	0.3
M12 Cab D-code Ethernet M0°-M0°, 0,3m, Ø6		M12 4-pin male D-coded Ethernet - 0° Straight	Robotic - 3D	0.14	No
WI1046-M12M4TM4T.3T	Connector 3	M12 4-pin male D-coded Ethernet - 0° Straight	Ethernet	4	0.3
M12 Cab D-code Ethernet M0°-M0°, 0,3m, Ø6		M12 4-pin male D-coded Ethernet - 0° Straight	Standard	0.13	No
WI1046-M12M4TM4T01R	Connector 3	M12 4-pin male D-coded Ethernet - 0° Straight	Ethernet	4	1
M12 Cab D-code Ethernet M0°-M0°, 1m, Ø7		M12 4-pin male D-coded Ethernet - 0° Straight	Robotic - 3D	0.14	No
WI1046-M12M4TM4T01T	Connector 3	M12 4-pin male D-coded Ethernet - 0° Straight	Ethernet	4	1



## MIS231S1EPH2S6

Int.Step 12-72VDC, Profinet, EncC-L, STO

### Cable information

Item number	Mount on	Cable con 1 +Con 1 angle	Cable application	Wires no totally	Cable length [m]
Item description		Cable con 2 +Con 2 angle	Cable flexibility	Wire [mm2]	Connector 1 LED
M12 Cab D-code Ethernet M0°-M0°, 1m, Ø6		M12 4-pin male D-coded Ethernet - 0° Straight	Standard	0.13	No
WI1046-M12M4TM4T02R	Connector 3	M12 4-pin male D-coded Ethernet - 0° Straight	Ethernet	4	2
M12 Cab D-code Ethernet M0°-M0°, 2,0m, Ø7		M12 4-pin male D-coded Ethernet - 0° Straight	Robotic - 3D	0.14	No
WI1046-M12M4TM4T02T	Connector 3	M12 4-pin male D-coded Ethernet - 0° Straight	Ethernet	4	2
M12 Cab D-code Ethernet M0°-M0°, 2,0m, Ø6		M12 4-pin male D-coded Ethernet - 0° Straight	Standard	0.13	No
WI1046-M12M4TM4T05R	Connector 3	M12 4-pin male D-coded Ethernet - 0° Straight	Ethernet	4	5
M12 Cab D-code Ethernet M0°-M0°, 5m, Ø7		M12 4-pin male D-coded Ethernet - 0° Straight	Robotic - 3D	0.14	No
WI1046-M12M4TM4T05T	Connector 3	M12 4-pin male D-coded Ethernet - 0° Straight	Ethernet	4	5
M12 Cab D-code Ethernet M0°-M0°, 5m, Ø6		M12 4-pin male D-coded Ethernet - 0° Straight	Standard	0.13	No
WI1046-M12M4TM4T10R	Connector 3	M12 4-pin male D-coded Ethernet - 0° Straight	Ethernet	4	10
M12 Cab D-code Ethernet M0°-M0°, 10m, Ø7		M12 4-pin male D-coded Ethernet - 0° Straight	Robotic - 3D	0.14	No
WI1046-M12M4TM4T10T	Connector 3	M12 4-pin male D-coded Ethernet - 0° Straight	Ethernet	4	10
M12 Cab D-code Ethernet M0°-M0°, 10m, Ø6		M12 4-pin male D-coded Ethernet - 0° Straight	Standard	0.13	No
WI1046-M12M4TM4T15R	Connector 3	M12 4-pin male D-coded Ethernet - 0° Straight	Ethernet	4	15
M12 Cab D-code Ethernet M0°-M0°, 15m, Ø7		M12 4-pin male D-coded Ethernet - 0° Straight	Robotic - 3D	0.14	No
WI1046-M12M4TM4T20R	Connector 3	M12 4-pin male D-coded Ethernet - 0° Straight	Ethernet	4	20
M12 Cab D-code Ethernet M0°-M0°, 20m, Ø7		M12 4-pin male D-coded Ethernet - 0° Straight	Robotic - 3D	0.14	No
WI1046-M12M4TM4T20T	Connector 3	M12 4-pin male D-coded Ethernet - 0° Straight	Ethernet	4	20
M12 Cab D-code Ethernet M0°-M0°, 20m, Ø6		M12 4-pin male D-coded Ethernet - 0° Straight	Standard	0.13	No
WI1046-M12M4V02TRJ45	Connector 3	M12 4-pin male D-coded Ethernet - 90° Angled	Ethernet	4	2
M12 Cab D-code Ethernet M90°-RJ45, 2m, Ø5		RJ45 male - 0° Straight	Standard	0.13	No
WI1046-M12M4V05TRJ45	Connector 3	M12 4-pin male D-coded Ethernet - 90° Angled	Ethernet	4	5
M12 Cab D-code Ethernet M90°-RJ45, 5m, Ø6		RJ45 male - 0° Straight	Standard	0.13	No
WI1046-M12M4VM4T.6N	Connector 3	M12 4-pin male D-coded Ethernet - 90° Angled	Ethernet	4	0.6
M12 Cab D-code Ethernet M90°-M0°, 0,6m, Ø6		M12 4-pin male D-coded Ethernet - 0° Straight	Standard	0.13	No
WI1046-M12M4VM4V.6N	Connector 3	M12 4-pin male D-coded Ethernet - 90° Angled	Ethernet	4	0.6
M12 Cab D-code Ethernet M90°-M90°, 0,6m, Ø6		M12 4-pin male D-coded Ethernet - 90° Angled	Standard	0.13	No
WI1048-M12M4TTR1	Connector 3	M12 4-pin male D-coded Ethernet - 0° Straight	Ethernet		Connector
M12 Con 4 p Male D Code Ethernet PressLock		- n/a	n/a		No
WI1046-M12M4TM4T.3R	Connector 3-2	M12 4-pin male D-coded Ethernet - 0° Straight	Ethernet	4	0.3
M12 Cab D-code Ethernet M0°-M0°, 0,3m, Ø6		M12 4-pin male D-coded Ethernet - 0° Straight	Robotic - 3D	0.14	No
WI1046-M12M4TM4T.3T	Connector 3-2	M12 4-pin male D-coded Ethernet - 0° Straight	Ethernet	4	0.3
M12 Cab D-code Ethernet M0°-M0°, 0,3m, Ø6		M12 4-pin male D-coded Ethernet - 0° Straight	Standard	0.13	No
WI1046-M12M4TM4T01R	Connector 3-2	M12 4-pin male D-coded Ethernet - 0° Straight	Ethernet	4	1
M12 Cab D-code Ethernet M0°-M0°, 1m, Ø7		M12 4-pin male D-coded Ethernet - 0° Straight	Robotic - 3D	0.14	No
WI1046-M12M4TM4T01T	Connector 3-2	M12 4-pin male D-coded Ethernet - 0° Straight	Ethernet	4	1
M12 Cab D-code Ethernet M0°-M0°, 1m, Ø6		M12 4-pin male D-coded Ethernet - 0° Straight	Standard	0.13	No
WI1046-M12M4TM4T02R	Connector 3-2	M12 4-pin male D-coded Ethernet - 0° Straight	Ethernet	4	2
M12 Cab D-code Ethernet M0°-M0°, 2,0m, Ø7		M12 4-pin male D-coded Ethernet - 0° Straight	Robotic - 3D	0.14	No
WI1046-M12M4TM4T02T	Connector 3-2	M12 4-pin male D-coded Ethernet - 0° Straight	Ethernet	4	2
M12 Cab D-code Ethernet M0°-M0°, 2,0m, Ø6		M12 4-pin male D-coded Ethernet - 0° Straight	Standard	0.13	No
WI1046-M12M4TM4T05R	Connector 3-2	M12 4-pin male D-coded Ethernet - 0° Straight	Ethernet	4	5
M12 Cab D-code Ethernet M0°-M0°, 5m, Ø7		M12 4-pin male D-coded Ethernet - 0° Straight	Robotic - 3D	0.14	No
WI1046-M12M4TM4T05T	Connector 3-2	M12 4-pin male D-coded Ethernet - 0° Straight	Ethernet	4	5
M12 Cab D-code Ethernet M0°-M0°, 5m, Ø6		M12 4-pin male D-coded Ethernet - 0° Straight	Standard	0.13	No
WI1046-M12M4TM4T10R	Connector 3-2	M12 4-pin male D-coded Ethernet - 0° Straight	Ethernet	4	10
M12 Cab D-code Ethernet M0°-M0°, 10m, Ø7		M12 4-pin male D-coded Ethernet - 0° Straight	Robotic - 3D	0.14	No
WI1046-M12M4TM4T10T	Connector 3-2	M12 4-pin male D-coded Ethernet - 0° Straight	Ethernet	4	10
M12 Cab D-code Ethernet M0°-M0°, 10m, Ø6		M12 4-pin male D-coded Ethernet - 0° Straight	Standard	0.13	No
WI1046-M12M4TM4T15R	Connector 3-2	M12 4-pin male D-coded Ethernet - 0° Straight	Ethernet	4	15
M12 Cab D-code Ethernet M0°-M0°, 15m, Ø7		M12 4-pin male D-coded Ethernet - 0° Straight	Robotic - 3D	0.14	No
WI1046-M12M4TM4T20R	Connector 3-2	M12 4-pin male D-coded Ethernet - 0° Straight	Ethernet	4	20
M12 Cab D-code Ethernet M0°-M0°, 20m, Ø7		M12 4-pin male D-coded Ethernet - 0° Straight	Robotic - 3D	0.14	No
WI1046-M12M4TM4T20T	Connector 3-2	M12 4-pin male D-coded Ethernet - 0° Straight	Ethernet	4	20
M12 Cab D-code Ethernet M0°-M0°, 20m, Ø6		M12 4-pin male D-coded Ethernet - 0° Straight	Standard	0.13	No



## MIS231S1EPH2S6

Int.Step 12-72VDC, Profinet, EncC-L, STO

### Cable information

Item number	Mount on	Cable con 1 +Con 1 angle	Cable application	Wires no totally	Cable length [m]
Item description		Cable con 2 +Con 2 angle	Cable flexibility	Wire [mm2]	Connector 1 LED
WI1046-M12M4VM4T.6N	Connector 3-2	M12 4-pin male D-coded Ethernet - 90° Angled Ethernet		4	0.6
M12 Cab D-code Ethernet M90°-M0°, 0,6m, Ø6		M12 4-pin male D-coded Ethernet - 0° Straight	Standard	0.13	No
WI1046-M12M4VM4V.6N	Connector 3-2	M12 4-pin male D-coded Ethernet - 90° Angled Ethernet		4	0.6
M12 Cab D-code Ethernet M90°-M90°, 0,6m, Ø6		M12 4-pin male D-coded Ethernet - 90° Angled Standard		0.13	No
WI1005-M12M17SAA01	Connector 4	M12 17-pin male A-coded - 0° Straight		n/a	Connector
M12 17-pin male Axis 1 Without wire		n/a - n/a	n/a	n/a	No
WI1005-M12M17SAA01-1	Connector 4	M12 17-pin male A-coded - 0° Straight		n/a	Connector
M12 17-pin male Axis 1, with wire 1,2m		n/a - n/a		n/a	No
WI1005-M12M17SAA02	Connector 4	M12 17-pin male A-coded - 0° Straight		n/a	Connector
M12 17-pin male Axis 2 Without wire		n/a - n/a	n/a	n/a	No
WI1005-M12M17SAA03	Connector 4	M12 17-pin male A-coded - 0° Straight		n/a	Connector
M12 17-pin male Axis 3 Without wire		n/a - n/a	n/a	n/a	No
WI1005-M12M17SAA04	Connector 4	M12 17-pin male A-coded - 0° Straight		n/a	Connector
M12 17-pin male Axis 4 Without wire		n/a - n/a	n/a	n/a	No
WI1005-M12M17SAA05	Connector 4	M12 17-pin male A-coded - 0° Straight		n/a	Connector
M12 17-pin male Axis 5 Without wire		n/a - n/a	n/a	n/a	No
WI1005-M12M17SAA06	Connector 4	M12 17-pin male A-coded - 0° Straight		n/a	Connector
M12 17-pin male Axis 6 Without wire		n/a - n/a	n/a	n/a	No
WI1005-M12M17SAA06-1	Connector 4	M12 17-pin male A-coded - 0° Straight		n/a	Connector
M12 17-pin male Axis 6 with wire 1,2m		n/a - n/a		n/a	No
WI1005-M12M17SAA07	Connector 4	M12 17-pin male A-coded - 0° Straight		n/a	Connector
M12 17-pin male Axis 7 Without wire		n/a - n/a	n/a	n/a	No
WI1005-M12M17SAA08	Connector 4	M12 17-pin male A-coded - 0° Straight		n/a	Connector
M12 17-pin male Axis 8 Without wire		n/a - n/a	n/a	n/a	No
WI1005-M12M17SAA09	Connector 4	M12 17-pin male A-coded - 0° Straight		n/a	Connector
M12 17-pin male Axis 9 Without wire		n/a - n/a	n/a	n/a	No
WI1005-M12M17SAA10	Connector 4	M12 17-pin male A-coded - 0° Straight		n/a	Connector
M12 17-pin male Axis 10 Without wire		n/a - n/a	n/a	n/a	No
WI1008-M12M17SR1	Connector 4	M12 12-pin male A-coded - 0° Straight		n/a	Connector
M12 Con 17p Male 0° Metal housing 5.4-8.2mm cable		- n/a	n/a	n/a	No
WI1009-M12M17T01N	Connector 4	M12 17-pin male A-coded - 0° Straight	Basic I/O, Com	17	1
M12 Shl Cable 1m 17p Mal 0° MISxx,Ex41 twisted		Open Ended - n/a	Standard	0.061	No
WI1009-M12M17T05N	Connector 4	M12 17-pin male A-coded - 0° Straight	Basic I/O, Com	17	5
M12 Shl Cable 5m 17p Mal 0° MISxx,Ex41 twisted		Open Ended - n/a	Standard	0.061	No
WI1009-M12M17T10R	Connector 4	M12 17-pin male A-coded - 0° Straight		17	5
M12 Shl Cable 10m 17p Mal 0° MISxx,Ex41 twisted		Open Ended - n/a	Robotic - 3D	0.061	No
WI1009-M12M17T20N	Connector 4	M12 17-pin male A-coded - 0° Straight	Basic I/O, Com	17	20
M12 Shl Cable 20m 17p Mal 0° MISxx,Ex41 twisted		Open Ended - n/a	Standard	0.061	No
WI1009-M12M17TF17T.5	Connector 4	M12 17-pin male A-coded - 0° Straight	Basic I/O, Com	17	0.5
M12 Shl Cable.5m Male17p0°-Female 17p0° twist pair		M12 17-pin female A-coded - 0° Straight	Standard	0.061	No
WI1009-M12M17TF17T01	Connector 4	M12 17-pin male A-coded - 0° Straight	Basic I/O, Com	17	1
M12 Shl Cable 1m Male17p0°-Female 17p0° twist pair		M12 17-pin female A-coded - 0° Straight	Standard	0.061	No
WI1009-M12M17TF17T02	Connector 4	M12 17-pin male A-coded - 0° Straight	Basic I/O, Com	17	2
M12 Shl Cable 2m Male17p0°-Female 17p0° twist pair		M12 17-pin female A-coded - 0° Straight	Standard	0.061	No
WI1009-M12M17TF17T03	Connector 4	M12 17-pin male A-coded - 0° Straight	Basic I/O, Com	17	3
M12 Shl Cable 3m Male17p0°-Female 17p0° twist pair		M12 17-pin female A-coded - 0° Straight	Standard	0.061	No
WI1009-M12M17TF17T04	Connector 4	M12 17-pin male A-coded - 0° Straight	Basic I/O, Com	17	4
M12 Shl Cable 4m Male17p0°-Female 17p0° twist pair		M12 17-pin female A-coded - 0° Straight	Standard	0.061	No
WI1009-M12M17V05N	Connector 4	M12 17-pin male A-coded - 90° Angled	Basic I/O, Com	17	5
M12 Shl Cable 5m 17p Mal 90° MISxx,Ex41 twisted		Open Ended - n/a	Standard	0.061	No
WI1009-M12M17V10N	Connector 4	M12 17-pin male A-coded - 90° Angled	Basic I/O, Com	17	10
M12 Shl Cable 10m 17p Mal 90° MISxx,Ex41 twisted		Open Ended - n/a	Standard	0.061	No
RS485-M12-1-5-17	Connector 4 RS485	M12 17-pin male A-coded - 0° Straight	Communication	3	5
RS485 M12-17pin DSub, 5m v1.1		D-Sub 9-pin female - RS485 - 0° Straight	Cable chains - 2D	0,32	No
WI1010-M08M4STO	Connector STO	M08 4-pin male A-coded - 0° Straight	STO	4	Connector



## MIS231S1EPH2S6

Int.Step 12-72VDC, Profinet, EncC-L, STO

### Cable information

Item number	Mount on	Cable con 1 +Con 1 angle	Cable application	Wires no totally	Cable length [m]
Item description		Cable con 2 +Con 2 angle	Cable flexibility	Wire [mm2]	Connector 1 LED
M8 STO Disable plug for MIS17/23/34/43		- n/a	n/a	0.2	No
WI1010-M08M4T03P	Connector STO	M08 4-pin male A-coded - 0° Straight	STO	4	3
M8 STO 4Pin Male 0° Con Shl Yel 3m 1xcon, MIS		Open Ended - n/a		0.2	No
WI1010-M08M4T05P	Connector STO	M08 4-pin male A-coded - 0° Straight	STO	4	10
M8 STO 4Pin Male 0° Con Shl Yel 5m 1xcon, MIS		Open Ended - n/a		0.2	No
WI1010-M08M4T15P	Connector STO	M08 4-pin male A-coded - 0° Straight	STO	4	15
M8 STO 4Pin Male 0° Con. shl. Yel 15m 1xCon, MIS		Open Ended - n/a		0.2	No
WI1010-M08M4T20P	Connector STO	M08 4-pin male A-coded - 0° Straight	STO	4	20
M8 STO 4P Male 0° Con. shl. Yel 20m		Open Ended - n/a		0.2	No
WI1010-M08M4TM4T10P	Connector STO	M08 4-pin male A-coded - 0° Straight	STO	4	10
M8 STO 4P Male 0°/4P Male 0° shl. Yel10m 2xCon MIS		M08 4-pin male A-coded - 0° Straight		0.2	No
WI1010-M08M4TM4T20P	Connector STO	M08 4-pin male A-coded - 0° Straight	STO	4	20
M8 STO 4P Male 0°/4P Male 0° shl. Yel20m 2xCon MIS		M08 4-pin male A-coded - 0° Straight		0.2	No
WI1010-M08M4V05P	Connector STO	M08 4-pin male A-coded - 90° Angled	STO	4	5
M8 STO 4Pin Male 90° Con. shl. Yel 5m 1xCon MIS		Open Ended - n/a		0.2	No
WI1010-M08M4V10P	Connector STO	M08 4-pin male A-coded - 90° Angled	STO	4	10
M8 STO 4Pin Male 90° Con. shl. Yel 10m 1xCon MIS		Open Ended - n/a		0.2	No
WI1010-M08M4VF4T01P	Connector STO	M08 4-pin male A-coded - 90° Angled	STO	4	1
M8 STO 4P Male 90°/4P Fem 0° shl. yel 1m 2xCon		M08 4-pin female A-coded - 0° Straight	Standard	0.2	No
WI1010-M08M4VF4T02P	Connector STO	M08 4-pin male A-coded - 90° Angled	STO	4	2
M8 STO 4P Male 90°/4P Fem 0° shl. yel 2m 2xCon		M08 4-pin female A-coded - 0° Straight	Standard	0.2	No
WI1010-M08M4VF4T03P	Connector STO	M08 4-pin male A-coded - 90° Angled	STO	4	3
M8 STO 4P Male 90°/4P Fem 0° shl. yel 3m 2xCon		M08 4-pin female A-coded - 0° Straight	Standard	0.2	No
WI1010-M08M4VM4V10P	Connector STO	M08 4-pin male A-coded - 90° Angled	STO	4	10
M8 STO 4P Male 90°/4P Male 90° shl. Yel 10m 2xCon		M08 4-pin male A-coded - 90° Angled		0.2	No
WI1010-M08M4VM4V20P	Connector STO	M08 4-pin male A-coded - 90° Angled	STO	4	20
M8 STO 4P Male 90°/4P Male 90° shl. Yel 20m 2xCon		M08 4-pin male A-coded - 90° Angled		0.2	No