

The MAC motor[®]. AC-servo motors with integrated driver MAC400 to MAC3000

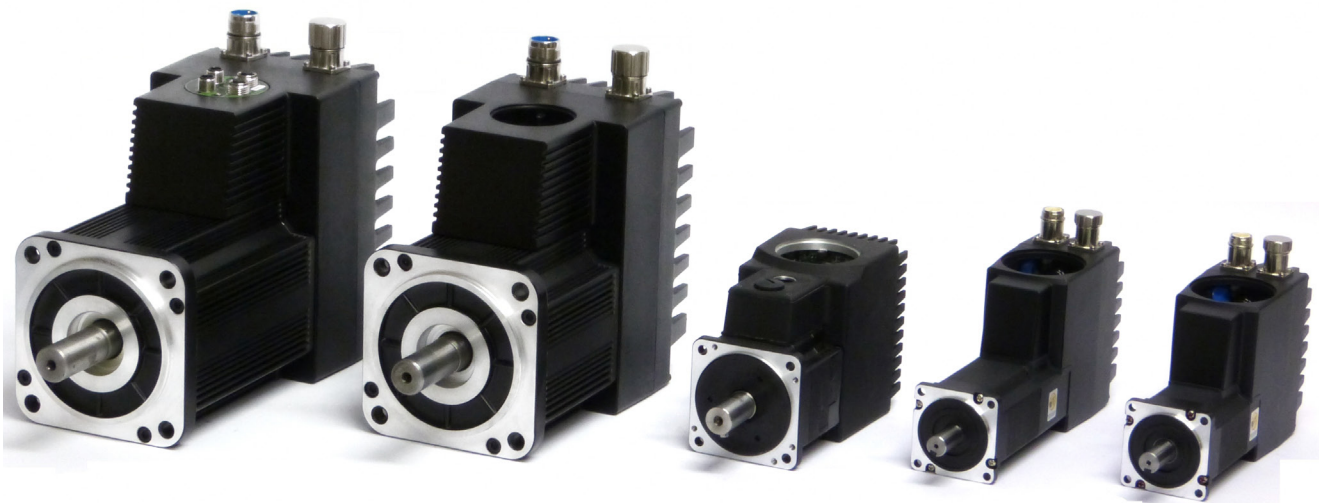

The MAC series of brushless servo motors with integrated electronics represents a major step forward. All the necessary electronics in a servo system are integrated in the motor itself.

In the past, a traditional motor system has typically been based on a central controller unit located remote from the motor. This configuration however has the negative effect that installation costs are a major part of the total expense of building machinery.

The basic idea of the MAC motors is to minimize these costs but also to make a component that is much better protected against electrical noise which can be a typical problem when using long cables between the controller and motor.

The servo motor, hall sensor, encoder and electronics are specially developed

by JVL so that together they form a closed unit in which the power driver and controller are mounted inside the motor in a closed section. The advantages of this solution are:

- De-central intelligence.
- Simple installation. No cables between motor and driver.
- EMC safe. Switching noise remains within motor.
- Compact. Does not take space in cabinet. Typically a 3/5 core cable is used from PLC or similar to MAC motor.
- 1x115/230 or 3x400VAC for driver voltage.
- 24VDC for control circuits.
- Option for built-in brake and/or multturn absolute encoder.
- Uses the same expansion modules as the MAC 50-141series.
- Built-in mains supply filter.
- CE approved/UL approved (400,800)

or pending (1500-3000).

- IP55 and IP66
- μ PLC built-in.
- Low price.

Interface possibilities to the MAC motor:

- From PC/PLC with drive commands via RS232/RS485/RS422
- 2 x analogue inputs $\pm 10V$ input for speed or torque control – 11 bit + sign.
- Pulse/dir. or quadrature inputs.
- A+B encoder output.
- Module option for Ethernet, Profibus-DP, CanOpen, Devicenet, High-speed serial bus etc.

The MAC motor can be controlled with $\pm 10V$ for speed or torque control with encoder feedback to one master motion controller.

Continued on next page

Furthermore the MAC motor can replace an arbitrary step or servo system, being based on pulse and direction signals. There is a built-in electronic gear so that the MAC motor can simulate all possible step resolutions. The MAC motor can thus replace all step- and servo-systems without change in the PLC/PC/controller

software.

Adaptation/replacement of existing step motor/servo systems can therefore be achieved quickly.

Parameters are set up via the RS232 port from a Windows program.

The supply voltage is 115 or 230VAC for the drive MAC400 and MAC800 and 3x400VAC for MAC1500 and 3000 and 24VDC for the control circuit.

The motors offer a power of 400, 750, 1500 or 3000W. Standard flanges so that the MAC motor can replace other servo motors directly without mechanical changes.

The connectors for the modules can be chosen as DSUB, M12 plug or cable glands. Backlash free and planetary gears in different ratios can be delivered from stock.

System and feature overview

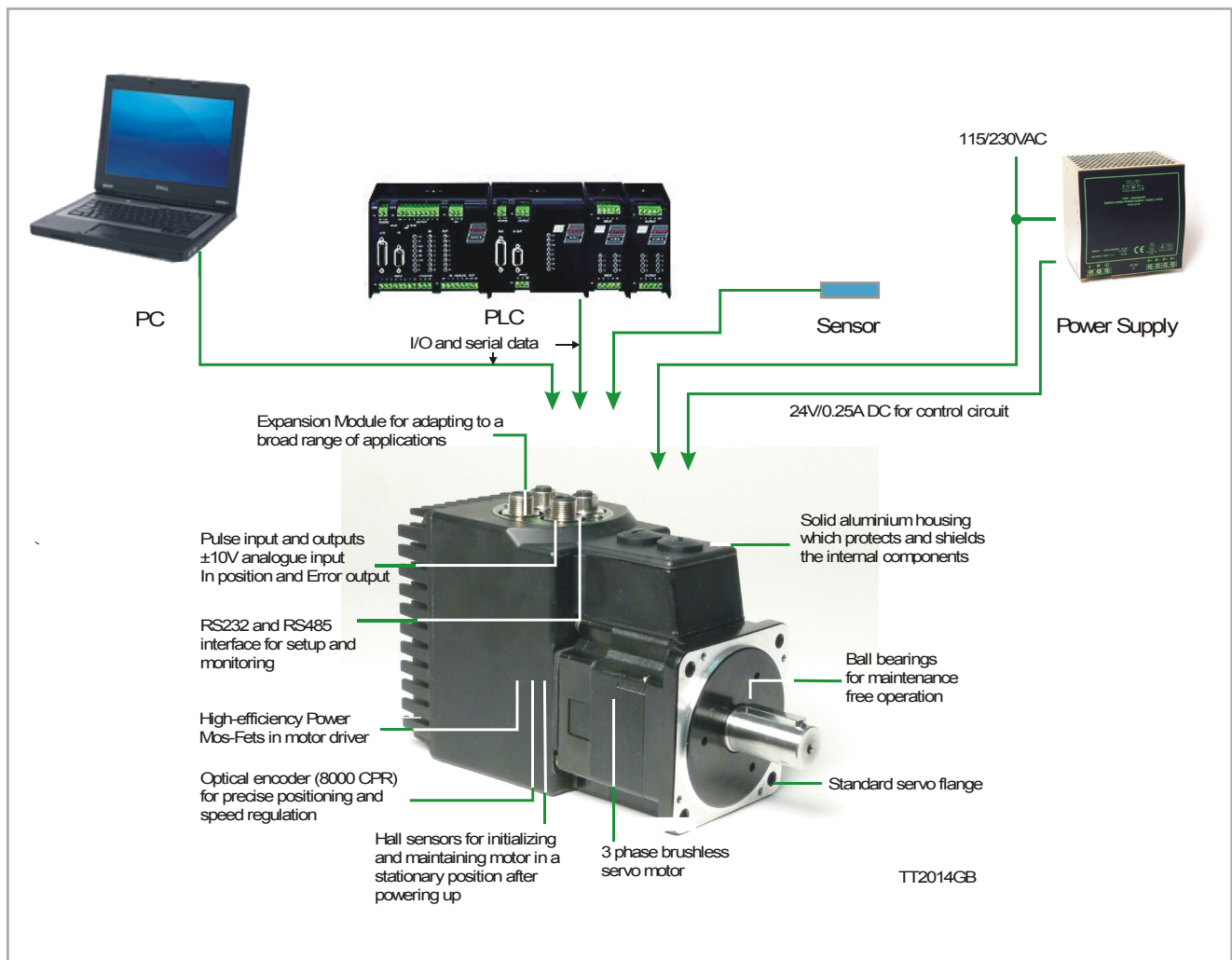

Modes of Operation (Basic Motor)

Gear Mode

In this mode the MAC motor functions as in a step motor system. The motor moves one step each time a voltage pulse is applied to the step-pulse input. Velocity, acceleration and deceleration are determined by the external frequency. Use of an encoder enables monitoring and adjustment during motor operation – a feature that is not possible with a standard step motor system. In addition, the MAC motor also provides a facility for electronic gearing at a keyed-in ratio with analogue speed offset.

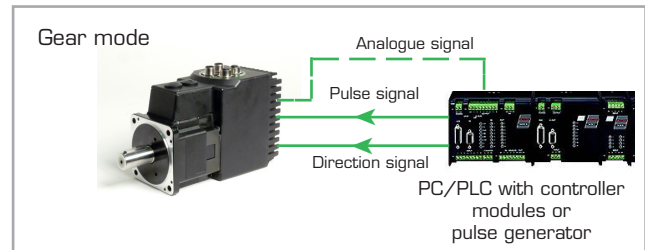

Positioning Mode

In this mode the MAC motor positions the motor via commands sent over the RS422 or serial interface. Various operating parameters can be changed continuously while the motor is running. This mode of operation is used primarily in systems where the Controller is permanently connected to a PC/PLC via the interface. This mode is also well suited for setting up and testing systems.

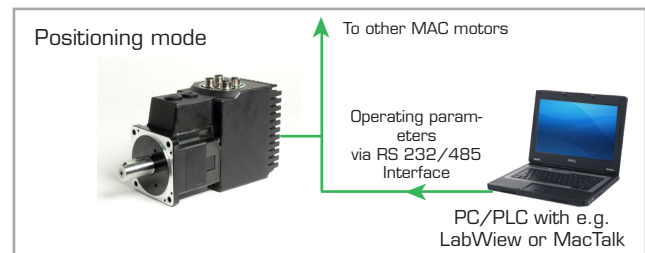

Serial Mode (FastMac)

In this mode the MAC motor's registers contain the parameter sets, positions, velocities, etc., required for the actual system. The registers can be selected and executed by a single byte sent via the serial interface. This mode provides maximum utilisation of the MAC motor's features since the MAC motor itself takes care of the entire positioning sequence.

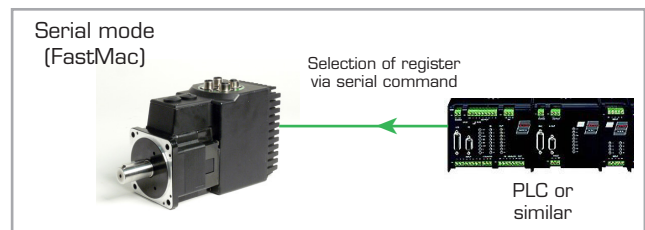

Velocity / Torque Mode

In this mode the MAC motor controls the motor velocity/torque via the analogue input. This mode is typically used for simple tasks or for applications in which an overall unit, such as a PC-board or PLC, controls velocity and positioning. Encoder A and B signals can be connected to the overall controller to close the servo loop.

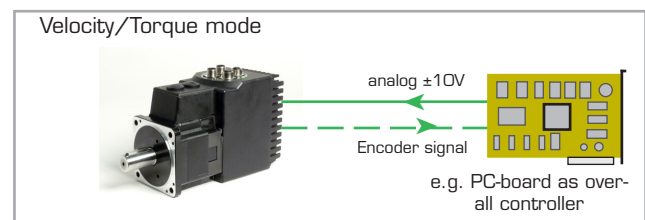

Safe Torque Off (STO)

The STO function is the most common and basic drive-integrated safety function. It ensures that no torque-generating energy can continue to act upon a motor and prevents unintentional starting, without the need to remove the mains power from the motor.

Effect

This function is a mechanism that prevents the motor from restarting unexpectedly. The STO function safely disrupts vital pulses of the control system necessary to the motor to generate torque. The motor is reliably torque-free. This state is monitored internally in the motor. In the event of an error in the STO circuitry the motor

is pacified via the control system, and will refuse to start again before the error is fixed.

Applications

STO has the immediate effect that the motor cannot supply any torque-generating energy. STO can be used wherever the motor will be brought to a standstill in a sufficiently short time by the load torque, friction or optionally via a build in electromechanical brake, or where coasting down of the motor is not relevant to safety. STO enables safe working when one or both of the "STO enable signals" are disconnected. It has a wide range of use in machines/systems with moving

axes, e.g. handling, conveyor technology.

Customer benefits

The advantage of the integrated STO safety function compared with standard safety technology using electro-mechanical switch gear is the elimination of separate components thereby reducing setup and maintenance costs. No electromechanical components are utilized in this solution thereby eliminating wear issues.

IT MUST BE NOTED THAT THIS SOLUTION IS NOT CERTIFIED BY ANY THIRD PARTY.



Torque versus speed

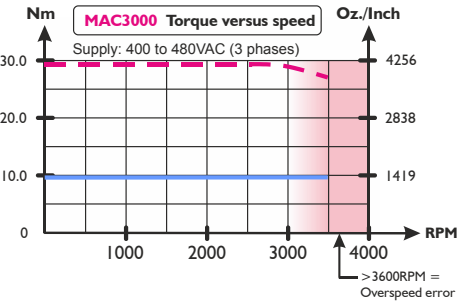
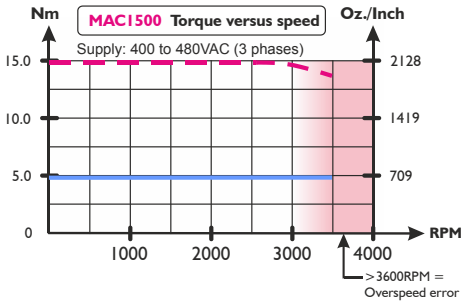
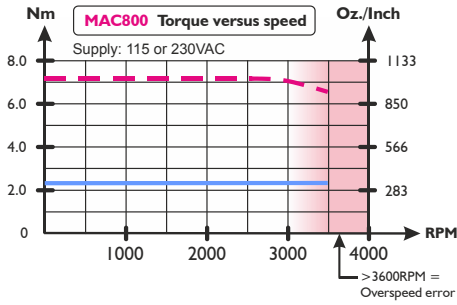
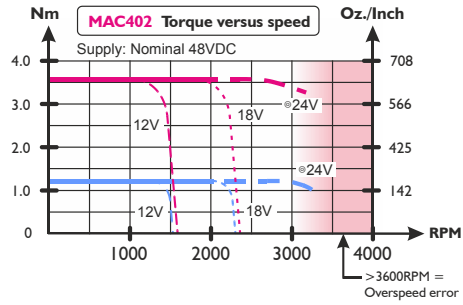
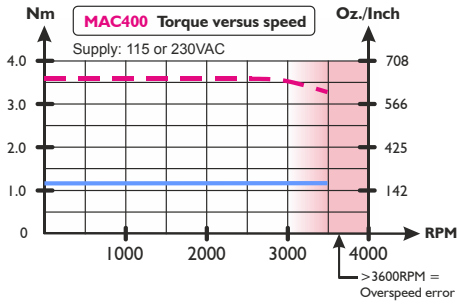

Conditions:
 Supply voltage = See individual plot
 Ambient temperature = 20°C
 Torque setting = 100%
 Load setting = 1.0

Operation above 3000 RPM can be done, but losses in the motor make it impossible to operate in this area continuously

— = Peak Torque
 — = Average Torque

TT1542-01GB

Software, MacTalk

Setup save/open
 The complete setup can be either saved or reloaded from a file using these buttons

Startup mode
 The basic functionality of the MAC motor is set up in this field.

Profile Data
 All the main parameters for controlling the motor behaviour are set up in this field.

System control
 Use these buttons to save data permanently, reset the motor etc.

Error Handling
 Use these fields to define error limits for the position range etc.

Input/Outputs
 The functionality of the I/O's is specified here.

Motor status
 This field shows the actual motor load, position and speed etc.

Inputs
 This field shows the actual supply voltage, the speed at the pulse input and the voltage at the analogue input.

Errors
 If a fatal error occurs, information will be displayed here.

Zero Search
 All the parameters regarding the position zero search can be specified here.

Undervoltage handling
 Determine what happens if the supply voltage gets too low..

MAC motor connection information Always shows if the motor is on line or not.



MAC402 Integrated Servo Motor 12-48 VDC



The MAC402 motor is a 400W motor with Battery Supply 12-48VDC. Peak power up to 1200W. Choose between model with or without Brakes. IP55 standard. IP66 optional. Wireless, Industrial Ethernet or PLC built-in.
 Motor versions:
 • MAC402-D2, standard version
 • MAC402-D5, with built-in brake

Features:
 You have the exact same features as in the AC-version, MAC400. Only difference is that MAC402 do not have an extra M16 connector for external power dump, since the breaking power is used for charging the battery supply (alternatively the DC power supply must be able to handle return power from the motor). In many applications it is not necessary

to choose a 750W or larger motor as the 400W (1200W peak) motor will be sufficient, thereby reducing cost and saving space. MAC402 options include: Brake, absolute multi turn encoder, and planetary & cycloidal gearheads.

Power Supplies

The Integrated MAC400 and MAC800 motors have a complete 90-240VAC power supply built in and furthermore only requires an 18 to 30 VDC for the

control circuitry. Having 2 independent supply circuits offer the feature that the supply voltage for the power circuitry (90-240VAC) can be removed

for safety reasons while the control circuitry can keep operating and thereby keep the position counter updated and keep other vital functions.

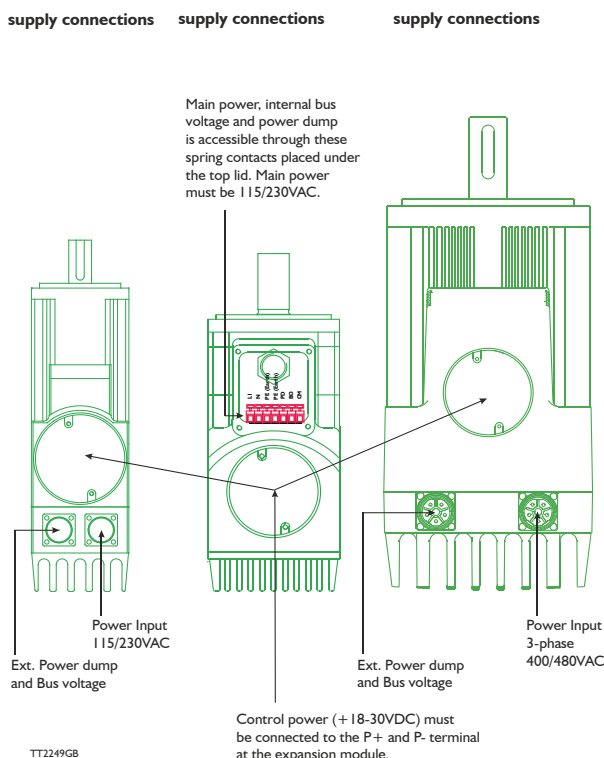

External Power Supplies

For external low voltage supply JVL can deliver a wide variety of high quality switchmode powersupplies. Power Supply PSU24-075 is recommended for control power supply. For detailed information ask for separate datasheets.



MAC selection chart

MAC Motors feature overview including expansion modules

TT0933-02GB

Feature \ Type	Unbalanced async. serial interface For setup/sending commands	Balanced async. serial interface For setup/sending commands	± 10V Analogue input For controlling speed/torque Also used for zero search	Pulse inputs Accepts pulse and direction or quadrature encoder signal	Pulse outputs 90 degree phase shifted outputs from internal encoder	Digital user inputs For control of program flow or motor start/stop	Digital user outputs For indicating the motor status or as output from the program	Ext. connector type	Protection class	Integrated brake
----------------	------------------------------------------------------------------	----------------------------------------------------------------	-----------------------------------------------------------------------------------	--------------------------------------------------------------------------	------------------------------------------------------------------------	------------------------------------------------------------------------	---------------------------------------------------------------------------------------	---------------------	------------------	------------------

Basic MAC motors

MAC400-D2 (-D3) Basic MAC motor IP55 (IP66)	5V TTL 19.2kbaud Full Duplex	RS422 (3) 19.2kbaud Full Duplex	✓	RS422 (3) 2.5Mhz or 150kHz (LP)	RS422 (3) 8192 cpr	No	Motor stat. 2 x NPN 25mA	AMP Molex JST	IP55 (IP66)	
MAC400-D5 (-D6) Basic MAC motor IP55 (IP66)	5V TTL 19.2kbaud Full Duplex	RS422 (3) 19.2kbaud Full Duplex	✓	RS422 (3) 2.5Mhz or 150kHz (LP)	RS422 (3) 8192 cpr	No	Motor stat. 2 x NPN 25mA	AMP Molex JST	IP55 (IP66)	✓
MAC402-D2 (-D3) Basic MAC motor IP55 (IP66)	5V TTL 19.2kbaud Full Duplex	RS422 (3) 19.2kbaud Full Duplex	✓	RS422 (3) 2.5Mhz or 150kHz (LP)	RS422 (3) 8192 cpr	No	Motor stat. 2 x NPN 25mA	AMP Molex JST	IP55 (IP66)	
MAC402-D5 (-D6) Basic MAC motor IP55 (IP66)	5V TTL 19.2kbaud Full Duplex	RS422 (3) 19.2kbaud Full Duplex	✓	RS422 (3) 2.5Mhz or 150kHz (LP)	RS422 (3) 8192 cpr	No	Motor stat. 2 x NPN 25mA	AMP Molex JST	IP55 (IP66)	✓
MAC800-D2 (-D3) Basic MAC motor IP55 (IP66)	5V TTL 19.2kbaud Full Duplex	RS422 (3) 19.2kbaud Full Duplex	✓	RS422 (3) 2.5Mhz or 150kHz (LP)	RS422 (3) 8000 cpr (8192)	No	Motor stat. 2 x NPN 25mA	AMP Molex JST	IP55 (IP66)	
MAC800-D5 (-D6) Basic MAC motor IP55 (IP66)	5V TTL 19.2kbaud Full Duplex	RS422 (3) 19.2kbaud Full Duplex	✓	RS422 (3) 2.5Mhz or 150kHz (LP)	RS422 (3) 8000 cpr (8192)	No	Motor stat. 2 x NPN 25mA	AMP Molex JST	IP55 (IP66)	✓
MAC1500-D2 (-D3) Basic MAC motor IP55 (IP66)	5V TTL 19.2kbaud Full Duplex	RS422 (3) 19.2kbaud Full Duplex	✓	RS422 (3) 2.5Mhz or 150kHz (LP)	RS422 (3) 8192 cpr	No	Motor stat. 2 x NPN 25mA	AMP Molex JST	IP55 (IP66)	
MAC1500-D5 (-D6) Basic MAC motor IP55 (IP66)	5V TTL 19.2kbaud Full Duplex	RS422 (3) 19.2kbaud Full Duplex	✓	RS422 (3) 2.5Mhz or 150kHz (LP)	RS422 (3) 8192 cpr	No	Motor stat. 2 x NPN 25mA	AMP Molex JST	IP55 (IP66)	✓
MAC3000-D2 (-D3) Basic MAC motor IP55 (IP66)	5V TTL 19.2kbaud Full Duplex	RS422 (3) 19.2kbaud Full Duplex	✓	RS422 (3) 2.5Mhz or 150kHz (LP)	RS422 (3) 8192 cpr	No	Motor stat. 2 x NPN 25mA	AMP Molex JST	IP55 (IP66)	
MAC3000-D5 (-D6) Basic MAC motor IP55 (IP66)	5V TTL 19.2kbaud Full Duplex	RS422 (3) 19.2kbaud Full Duplex	✓	RS422 (3) 2.5Mhz or 150kHz (LP)	RS422 (3) 8192 cpr	No	Motor stat. 2 x NPN 25mA	AMP Molex JST	IP55 (IP66)	✓

Basic modules

MAC00-CS (2) Conn. module w/cable glands No electronic features added	5V TTL 19.2kbaud Full Duplex	RS422 (3) 19.2kbaud Full Duplex	✓	RS422 (3) 2.5Mhz or 150kHz (LP)	RS422 (3)	No	Motor stat. 2 x NPN 25mA	Cable Gland	IP67 (1)	
MAC00-B1 Connector module w/DSUB connectors	RS232 19.2kbaud Full Duplex	RS422 (3) RS485 19.2k Full Duplex	✓	RS422 (3) 2.5Mhz or 150kHz (LP)	RS422 (3)	No	Motor stat. PNP 10-32V 100mA	DSUB Plug- able	IP42	
MAC00-B2 Connector module w/cable glands (2)	RS232 19.2kbaud Full Duplex	RS422 (3) RS485 19.2k Full Duplex	✓	RS422 (3) 2.5Mhz or 150kHz (LP)	RS422 (3)	No	Motor stat. PNP 10-32V 100mA	Cable Gland	IP67 (1)	
MAC00-B4 Connector module w/M12 connectors	RS232 19.2kbaud Full Duplex	RS422 (3) RS485 19.2k Full Duplex	✓	RS422 (3) 2.5Mhz or 150kHz (LP)	RS422 (3)	No	Motor stat. PNP 10-32V 100mA	M12 Conn.	IP67 (1)	
MAC00-B4 I Connector module w/M12 connectors	RS232 19.2kbaud Full Duplex	RS422 (3) RS485 19.2k Full Duplex	✓	RS422 (3) 2.5Mhz or 150kHz (LP)	RS422 (3)	6 In/Out. (selectable) 5-30V	No	M12 Conn.	IP67 (1)	

Industrial Ethernet modules

MAC00-Ex4 Ethernet module Basic version	5V TTL 19.2kbaud Full Duplex	No	✓	No	No	1 Input Opto isol. 5-30V	1 Output PNP 10-32V 15mA	M12 Conn.	IP67 (1)	
MAC00-Ex4 I Ethernet module Extended version	RS232 19.2kbaud Full Duplex	RS422 (3) RS485 19.2k Full Duplex	✓ x2	RS422 (3) 2.5Mhz or 150kHz (LP)	RS422 (3)	4 Inputs Opto isol. 5-30V	2 Outputs PNP 10-32V 15mA	M12 Conn.	IP67 (1)	



Expansion module overview.

TT1544-01GB

Feature \ Type	Unbalanced async. serial interface For setup/sending commands	Balanced async. serial interface For setup/sending commands	± 10V Analogue input For controlling speed/torque Also used for zero search	Pulse inputs Accepts pulse and direction or quadrature encoder signal	Pulse outputs 90 degree phase shifted outputs from internal encoder	Digital user inputs For control of program flow or motor start/stop	Digital user outputs For indicating the motor status or as output from the program	Ext. connector type	Protection class	Integrated brake
----------------	------------------------------------------------------------------	----------------------------------------------------------------	-----------------------------------------------------------------------------------	--------------------------------------------------------------------------	------------------------------------------------------------------------	------------------------------------------------------------------------	---------------------------------------------------------------------------------------	---------------------	------------------	------------------

Wireless modules

MAC00-FB4 Bluetooth module	RS232 19.2kbaud Full Duplex	RS422 (3) RS485 19.2k Full Duplex	✓	No	RS422 (3)	No	Motor stat. PNP 10-32V 100mA	M12 Conn.	IP67 (1)
MAC00-FZ4 Zigbee module - IEEE 802.15.4	RS232 19.2kbaud Full Duplex	RS422 (3) RS485 19.2k Full Duplex	✓	No	RS422 (3)	No	Motor stat. PNP 10-32V 100mA	M12 Conn.	IP67 (1)
MAC00-EW4 WLAN module	RS232 19.2kbaud Full Duplex	RS422 (3) RS485 19.2k Full Duplex	✓	No	RS422 (3)	No	Motor stat. PNP 10-32V 100mA	M12 Conn.	IP67 (1)

Fieldbus modules

MAC00-FC2 CAN-Open module w/cable glands	RS232 19.2kbaud Full Duplex	No	✓	No	No	6 Inputs Opto isol. 5-30V	2 Outputs PNP 10-32V 25mA	Cable Gland	IP67 (1)
MAC00-FC4 CAN-Open module w/M12 connectors	RS232 19.2kbaud Full Duplex	No	✓ ⁽⁴⁾	No	No	4 Inputs Opto isol. 5-30V (4)	2 Outputs PNP 10-32V 25mA (4)	M12 Conn.	IP67 (1)
MAC00-FD4 DeviceNet module w/M12 connectors	RS232 19.2kbaud Full Duplex	No	✓ ⁽⁴⁾	No	No	4 Inputs Opto isol. 5-30V (4)	2 Outputs PNP 10-32V 25mA (4)	M12 Conn.	IP67 (1)
MAC00-FP2 Profibus DP w/cable glands	RS232 19.2kbaud Full Duplex	No	✓	No	No	6 Inputs Opto isol. 5-30V	2 Outputs PNP 10-32V 25mA	Cable Gland	IP67 (1)
MAC00-FP4 Profibus DP w/M12 connectors	RS232 19.2kbaud Full Duplex	No	✓ ⁽⁴⁾	No	No	4 Inputs Opto isol. 5-30V (4)	2 Outputs PNP 10-32V 25mA (4)	M12 Conn.	IP67 (1)

Multiaxis modules

MAC00-FS1 RS485 High Speed. w/DSUB connectors. Multiaxis control	RS232 19.2kbaud Full Duplex	RS485 460kBaod Opto isol.	✓	RS422 (3) 2.5Mhz or 150kHz (LP)	RS422 (3)	4 Inputs Opto isol. 5-30V	2 Outputs PNP 10-32V 25mA	DSUB Plug- able	IP42
MAC00-FS4 RS485 High Speed. w/M12 connectors. Multiaxis control	RS232 19.2kbaud Full Duplex	RS485 460kBaod Opto isol.	✓	RS422 (3) 2.5Mhz or 150kHz (LP)	RS422 (3)	4 Inputs Opto isol. 5-30V	2 Outputs PNP 10-32V 25mA	M12 Conn.	IP67 (1)

Programmable modules

MAC00-RI Nano PLC w/ DSUB connect.	RS232 19.2kbaud Full Duplex	RS485 19.2kbaud Half Duplex	✓	No	No	8 Inputs Opto isol. 5-30V	4 Outputs PNP 10-32V 300mA	DSUB Plug- able	IP42
MAC00-R3 Nano PLC w/cable glands (2)	RS232 19.2kbaud Full Duplex	RS485 19.2kbaud HalfDuplex	✓	No	No	8 Inputs Opto isol. 5-30V	4 Outputs PNP 10-32V 300mA	Cable Gland	IP67 (1)
MAC00-R4 Nano PLC w/M12 circular connectors	RS232 19.2kbaud Full Duplex	RS485 19.2kbaud HalfDuplex	✓	No	No	8 Inputs Opto isol. 5-30V	4 Outputs PNP 10-32V 300mA	M12 Conn.	IP67 (1)

Process Control modules

MAC00-P4 Process module 4-20mA w/ only M12	RS232 19.2kbaud Full Duplex	RS422 (3) RS485 19.2k Full Duplex	✓	RS422 (3) 2.5Mhz or 150kHz (LP)	RS422 (3)	3 Inputs NO iso! 5-30V	2 Outputs PNP 10-32V 100mA	M12 Conn.	IP67 (1)
MAC00-P5 Process module 4-20mA w/M12+Harting connectors	RS232 19.2kbaud Full Duplex	RS422 (3) RS485 19.2k Full Duplex	✓	RS422 (3) 2.5Mhz or 150kHz (LP)	RS422 (3)	No	1 Output PNP 10-32V 100mA	M12+ Hart. Conn.	IP67 (1)

- 1) All these modules offer IP67 protection class. Please notice that the final protection class is limited by the actual motor used.
- 2) Can be ordered without cable (eg. MAC00-CS) or with cable in lengths of 2, 10 or 20 metres (eg. MAC-CS-10).
- 3) Either pulse input, pulse output or serial must be chosen. Not all of them at the same time.
- 4) Only a total of 4 I/O terminals are available.

Expansion modules

The JVL Integrated motors utilizes the unique module concept. Plug in expansion modules adapt the motor to the application. You can choose connector type, D-Sub. (IP42), cable glands (IP67) or M12 connectors (IP67) and you can choose freely between

Profibus, DeviceNet, CANopen or nano PLC communication. A High Speed and wireless module add to the possibilities. This means that you have possibilities as with no other motors on the market, and also important, you only pay for what you

need. Moreover, if you do not find the feature you need, please contact us, and we will develop your own module. All modules can be delivered with or with cables of up to 20m length.

	DSUB Connectors	Cable glands	M12 Connectors
Basic modules MAC00-B1, B2, B4 Connector module w/RS232 RS485 (non isolated) and LED's MAC00-B41 Connector module with Optical isolated RS232, Rs485 6 General digital I/O Support 2 multifunction I/O ports.	MAC00-B1 	MAC00-B2 	MAC00-B4 
	Not planned	Not planned	MAC00-B41 
Industrial Ethernet modules MAC00-EC4 EtherCAT® module MAC00-EI4 EthernetIP®module MAC00-EL4 Powerlink®module MAC00-EM4 Modbus TCP/IP®module MAC00-EP4 Profinet®module	    	Not planned	MAC00-EC4, EI4, EL4, EM4, EP4 
Industrial Ethernet modules extended IO MAC00-EC41 EtherCAT® module MAC00-EI41 EthernetIP®module MAC00-EL41 Powerlink®module MAC00-EM41 Modbus TCP/IP®module MAC00-EP41 Profinet®module	    	Not planned	MAC00-EC41, EI41, EL41, EM41, EP41 
Wireless modules MAC00-FB4 Wireless Bluetooth module MAC00-EZ4 Wireless Zigbee (IEEE 802.15.4) module MAC00-EW4 Wireless WLAN module	  	Not planned	MAC00-FB4, EZ4 and EW4 
Fieldbus modules MAC00-FC2, FC4 CANopen Supports DS402		Not planned	MAC00-FC2 
			MAC00-FC4 
MAC00-FD4 DeviceNet		Not planned	MAC00-FD4 
MAC00-FP2, FP4 Profibus DP 12Mbit with 6(4) Inputs and (2) outputs		Not planned	MAC00-FP2 
			MAC00-FP4 



	DSUB Connectors	Cable glands	M12 Connectors
Multiaxis modules MAC00-FS1, FS4 High speed serial RS485 Multiaxis 460kbaud	MAC00-FS1 	Not planned	MAC00-FS4 
Programmable modules MAC00-R1, R3, R4 Nano PLC with graphic programming interface 8 input and 4 outputs.	MAC00-R1 	MAC00-R3 	MAC00-R4 
Process control modules MAC00-P4 Process module 4-20mA input and output galvanic isolated. Only M12 Connectors	Not planned	Not planned	MAC00-P4 
MAC00-P5 Process module 4-20mA input and output galvanic isolated. Harting and M12 Connectors	Not planned	Not planned	MAC00-P5 
Rear plates MAC00-00/01/02 and MAC00-CS Rearplates with or without cable glandsConn. No electronic features included	MAC00-00 	MAC00-01 	MAC00-02 
			MAC00-CSxx 

TT1176-03GB

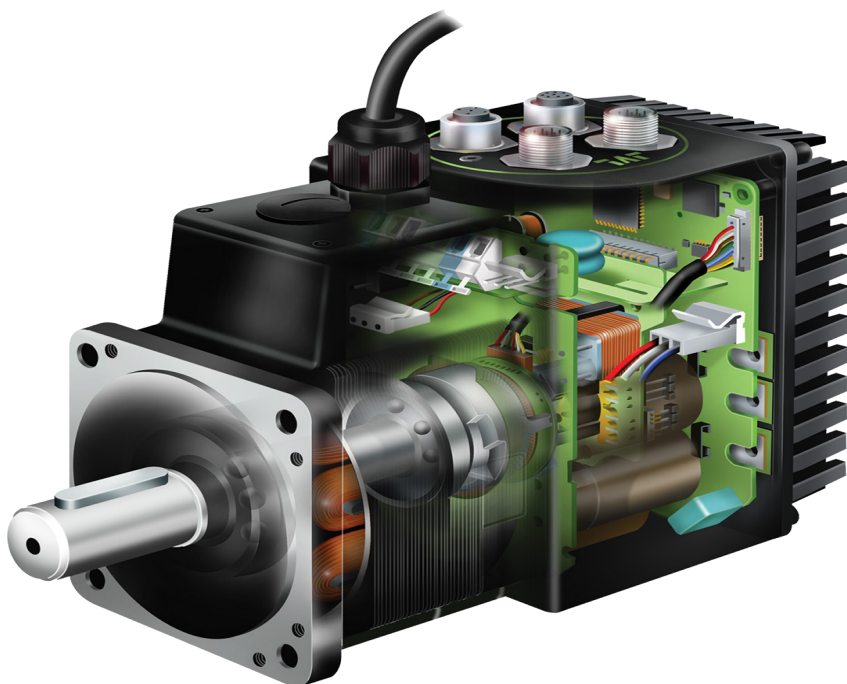

Technical Data

GENERAL		All data are specified for the MAC400-3000 motor only, i.e. without any expansion module mounted.				
Technology		AC-servomotor with built-in 2000 PPR encoder, hall sensor and 3 phase servo amplifier/controller.				
Controller Type		MAC400-D2 and D3	MAC400-D5 and D6 w. brake	MAC402-D2 and D3	MAC402-D5 and D6 w. brake	MAC800-D2 and D3
Controller capacity	Rated output @ 3000RPM	400W (0.54hp)	400W (0.54hp)	400W (0.54hp)	400W (0.54hp)	750W (1.00hp)
	Rated Torque RMS	1.28Nm (181.26oz-in)	1.28Nm (181.26oz-in)	1.28Nm (181.26oz-in)	1.28Nm (181.26oz-in)	2.38Nm (337.04oz-in)
	Peak Torque	3.8Nm (538.13oz-in)	3.8Nm (538.13oz-in)	3.8Nm (538.13oz-in)	3.8Nm (538.13oz-in)	6.8Nm (962.96oz-in)
	Inertia (kgcm ²)/(oz-in-s ²)	0.34/0.004815	0.36/0.005098	0.34/0.004815	0.36/0.005098	0.91/0.01289
	Max. angular acceleration	-rad/sec ²	-rad/sec ²	-rad/sec ²	-rad/sec ²	40000rad/sec ²
	Length	191mm (7.52")	225mm (8.86")	191mm (7.52")	225mm (8.86")	174mm (6.85") / 202mm (7.95")
	Weight (without expansion module)	2.3kg (5.11lb)	2.8kg (6.17lb)	2.3kg (5.11lb)	2.8kg (6.17lb)	3.5kg (7.716lb)
	Audible noise level (measured in 30cm distance)	-	(to be defined) dB(A)	-	(to be defined) dB(A)	-
	Backlash (when brake is activated)	-	<±1 degree	-	<±1 degree	
Controller Type		MAC800-D5 and D6 w. brake	MAC1500-D2 and D3	MAC1500-D5 and D6 w. brake	MAC3000-D2 and D3	MAC3000-D5 and D6 w. brake
Controller capacity	Rated output @ 3000RPM	750W (1.00hp)	1500W (2.04hp)	1500W (2.04hp)	3000W (4.08hp)	3000W (4.08hp)
	Rated Torque RMS	2.38Nm (337.04oz-in)	5.0Nm (708.06oz-in)	5.0Nm (708.06oz-in)	9.55Nm (1352.39oz-in)	9.55Nm (1352.39oz-in)
	Peak Torque	6.8Nm (962.96oz-in)	15.0Nm (2124.18oz-in)	15.0Nm (2124.18oz-in)	28.7Nm (4064.26oz-in)	28.7Nm (4064.26oz-in)
	Inertia (kgcm ²)/(oz-in-s ²)	1.13/0.016	13.96/0.198	14.10/0.200	27.83/0.394	27.98/0.396
	Max. angular acceleration	40000rad/sec ²	40000rad/sec ²	40000rad/sec ²	40000rad/sec ²	40000rad/sec ²
	Length	209mm (8.23") / 234mm (9,21")	250mm (9.84")	305.86mm (12.04")	312mm (12.28")	366mm (14.44")
	Weight (without expansion module)	4.3kg (9.48lb)	10.95kg (24.14lb)	13.15kg (28.99lb)	13.2kg (29.10lb)	17.1kg (37.70lb)
	Audible noise level (measured in 30cm distance)	65 dB(A)	-	65 dB(A)	-	65 dB(A)
	Backlash (when brake is activated)	<±1 degree	-	<±1 degree	-	<±1 degree
Speed range for MAC400-402		0-3000RPM with full torque. (Max 3500 RPM shortterm.) Overspeed protection trips at >4300RPM. Motor will shut down				
Speed range for MAC800-3000		0-3000RPM with full torque. Max 3500 RPM. Overspeed protection if speed>3600=motor will go in passive mode				
Amplifier control system		MAC400-800: Sinusoidal wave PWM control. 20kHz switching. MAC1500-3000: Sinusoidal wave PWM control. 5kHz switching.				
Filter:		6th order filter with only one inertia load factor parameter to be adjusted. Expert tuning also available for professionals				
Feedback. Standard incremental:		MAC400, MAC402, MAC1500 and MAC3000 : Incremental A and B encoder 8192 CPR. (Physical 2048 PPR) MAC800: Incremental A and B encoder 8000CPR (Physical 2000PPR)				
Optional absolute multiturn encoder:		Encoder 65535 CPR and 4096 rev.				
Input power supply for MAC400		115/230/240VAC (±10%) for main power circuit. 18-32VDC for control circuit. Consumption at 115-240VAC - see power supply section. Control circuitry consumption: MAC400D1, 2 and 3 (wo/brake) = Typical 0.22A @ 24VDC(5.3W). Control circuitry consumption: MAC400D4, 5 and 6 (w/brake) = Typical 0.58A @ 24VDC(14W).				
Input power supply for MAC402		Nominal 12-48VDC (±10%) for main power circuit. Recommended also for 12V battery applications. Consumption at 12-48VDC - see power supply section. 18-32VDC for control circuit. Control circuitry consumption: MAC400D1, 2 and 3 (wo/brake) = Typical 0.22A @ 24VDC(5.3W). Control circuitry consumption: MAC400D4, 5 and 6 (w/brake) = Typical 0.58A @ 24VDC(14W).				
Input power supply for MAC800		115/230/240VAC (±10%) for main power circuit. 18-32VDC for control circuit. Consumption at 115-240VAC - see power supply section. Control circuitry consumption: MAC800D1, 2 and 3 (wo/brake) =0.25A @ 24VDC(6W). Control circuitry consumption: MAC800D4, 5 and 6 (w/brake) =0.75A @ 24VDC(18W).				
Input power supply for MAC1500 and 3000		3 phase supply 400 to 480AC for driver circuit. Absolute max 550VAC ! 18-32VDC for control circuit. Control circuitry consumption: MAC1500 and 3000-D1, 2 and 3 (wo/brake) =0.3A @ 24VDC(8W). Control circuitry consumption: MAC1500 and 3000-D4, 5 and 6 (w/brake) =1.2A @ 24VDC(24W).				
Control mode		* ±10V Speed and Torque. A+B encoder outputs * Pulse/direction and 90° phase shifted A+B (Incremental). * RS422 or RS232 (5V) position and parameter commands * Gear mode with analog input speed offset + various options. * Sensor zero search or mechanical zero search.				
Flange and shaft dimension MAC400 and 402: MAC800: MAC1500 and 3000		Front: 60x60mm. Rear 63x115mm. Shaft Ø14mm Front: 80x80mm. Rear: 80x113mm. Shaft Ø19mm Front: 130x130mm. Rear: 130x203mm (excl. connectors). Shaft Ø24.0mm +0/-0.013mm				

Technical Data (continued)

POSITION (pulse inputs)			
Command input pulse	Pulse/direction or 90° phase shifted A+B. RS422		
Input frequency	0-8 MHz. 0-1MHz with input filter		
Electronic gear	A/B: A= -10000 to 10000, B=1 to 10000. Simulation of all step resolutions.		
Follow error register	32 bit		
In position width	0-32767 pulse		
Position range	32 bit. Infinity, Flip over at $\pm 2^{31}$ pulses.		
POSITION (serial communication)			
Communication facility	From PLC, PC etc via RS422 or asynchronous serial port RS232 with special cable. MacTalk JVL commands, special commands with high security.		
Communication baud rate	19200 bit/sec (19.2kBaud)		
Position range	$\pm 67\,000\,000$		
Speed range	0-3000 RPM.		
Digital resolution	0.3606 RPM		
Acceleration range	250 - 444675 RPM/sec		
Addressing	Point to point on RS422. Up to 32 units on the same serial RS232/RS485 interface with built-in expansion module. Address range 1-254		
Speed variance	Max ± 4 RPM variance between command and actual speed.		
SPEED/ TORQUE			
Analogue speed/torque input.	11bit + sign. Nom. input voltage $\pm 10V$. 10kOhm input resistance. Voltage range max. -10 to +32VDC. Offset typical $\pm 50mV$.		
Sampling rate at analogue input	750 Hz		
Encoder output signals	A+, A-, B+, B-, RS422. Line driver 5V outputs (SN75176). 90° Phase shifted.		
Analogue speed input	+voltage -> CW rotation. Shaft view		
Zero speed determination.	0 - rated speed.		
Speed variance at rated speed	Initial error @ 20°C: $\pm 0,0\%$	Power Supply: $\pm 10\%$: 0.0%	
	Load 0-300%: $\pm 0,0\%$	Ambient temperature 0-40°C: $\pm 0,0005\%$ ($\pm 50ppm$)	
Torque limit in speed mode	0-300% by parameter		
Analogue torque input	+voltage (positive torque) -> CW rotation. Shaft view		
Torque control accuracy	$\pm 10\%$ @ 20°C (Reproducibility)		
VARIOUS			
Electromechanical brake	Optional feature. The brake is activated automatically when an unrecoverable error situation occur.		
Regenerative	Integrated power dump. External attachment is possible		
Protective functions.	Error trace back. Overload I ² t, follow error, function error, regenerative overload (over voltage), software position limit. Abnormality in flash memory, under voltage, over current, temperature too high.		
LED functions	Power (Green LED), Error (Red LED). Note that the LED's are only visible when no module is mounted.		
Output signals	3 general purpose NPN 30V/25 mA outputs. Error and In position.		
Zero search	1: Automatic zero search with sensor connected to input (2 formats) 2: Mechanical zero search without sensor. (Torque controlled)		
Shaft load maximum MAC400 and 402: MAC800: MAC1500 and 3000:	Radial load: 24.5kg (13.5mm from flange). Axial load: 9.8kg. Radial load: 18kg (20mm from flange). Axial load: 11kg Radial load: xxN (xxmm from flange). Axial load: xxkg.		
Optional brake (-D5 or D6) MAC400-800 MAC1500-3000	Controlled automatic or from input. 3.25Nm, inertia 0.22cm ² , turn on time: 50ms, turn off time: 15ms Controlled automatic or from input. xxNm, turn on time: 50ms, turn off time: 15ms		
Rated power rate. (motor)	MAC400 and 402: 50.0 kW/s	MAC800: 62.8 kW/s	MAC1500-3000: xxx kW/s
Mechanical time constant. (motor)	MAC400 and 402: 0.59 \pm 10% ms	MAC800: 0.428 \pm 10% ms	MAC1500-3000: ?
Electrical time constant. (motor)	MAC400 and 402: 3.5 \pm 10% ms	MAC800: 4.122 \pm 10% ms	MAC1500-3000: ?
Standards	MAC400 and 402: CE approved/UL pending MAC800: CE approved/UL recognized file number E254947 MAC1500: CE approved/UL recognized file number E254947 - 20120725 Pending MAC3000: CE approved/UL recognized file number E254947 - 20130524 Pending		
Protection	MAC400: IP55 and IP65 MAC402: IP55 (IP65 on request) MAC800: IP55 (IP42 and IP67 on request) MAC1500 and 3000: IP55 (-D2 or D5 version). IP67 (D3 or D6 version)		
Usage / Storage Temperature	Ambient 0 to +40°C (32-104°F)/ Storage (power not applied): -20 to +85°C. (-4 to 185°F) (Humidity 90%). Temperature warning is given before reaching max. Temperature shut down and error message generated at 84°C (183F). The heatsink fan in MAC800-3000 starts at 55°C (131F).		

Mechanical dimensions MAC400

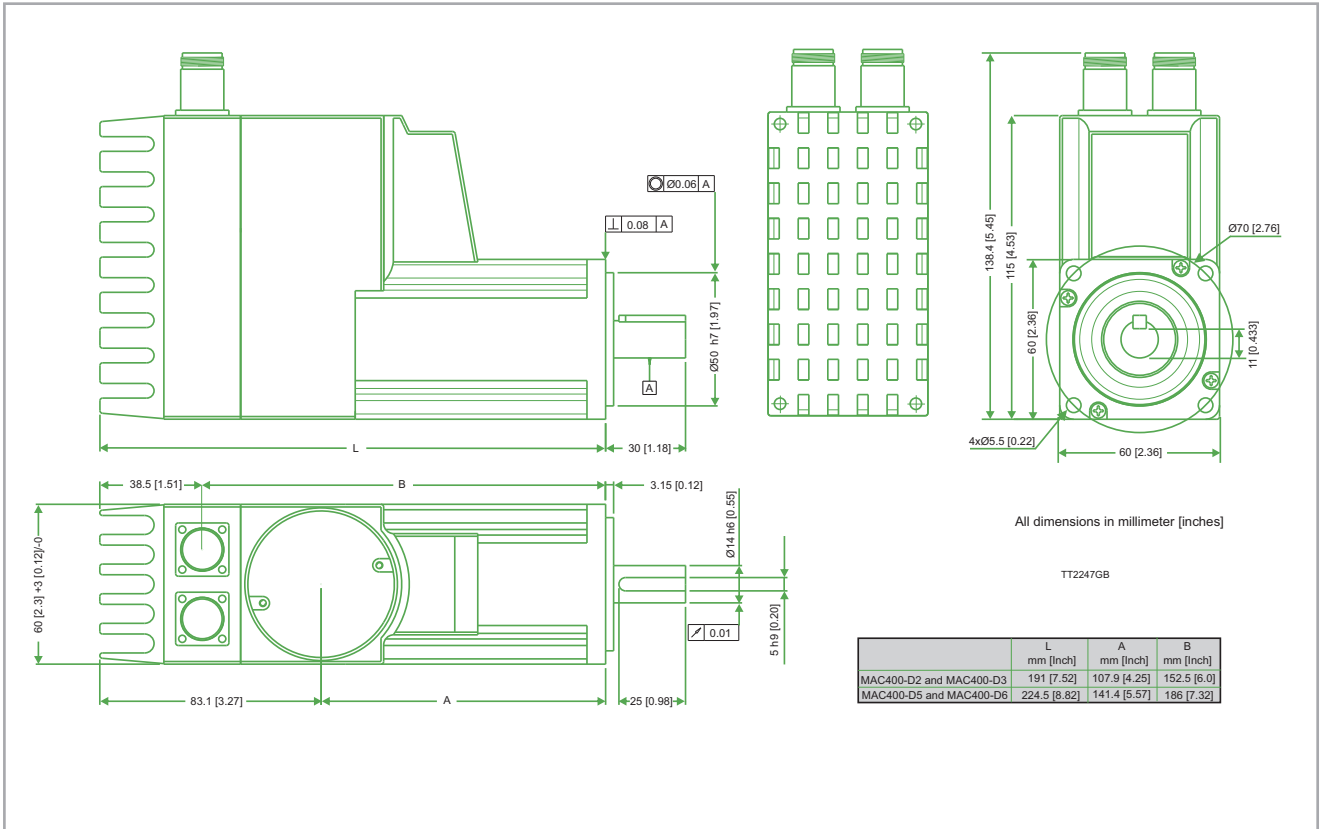

Mechanical dimensions MAC402

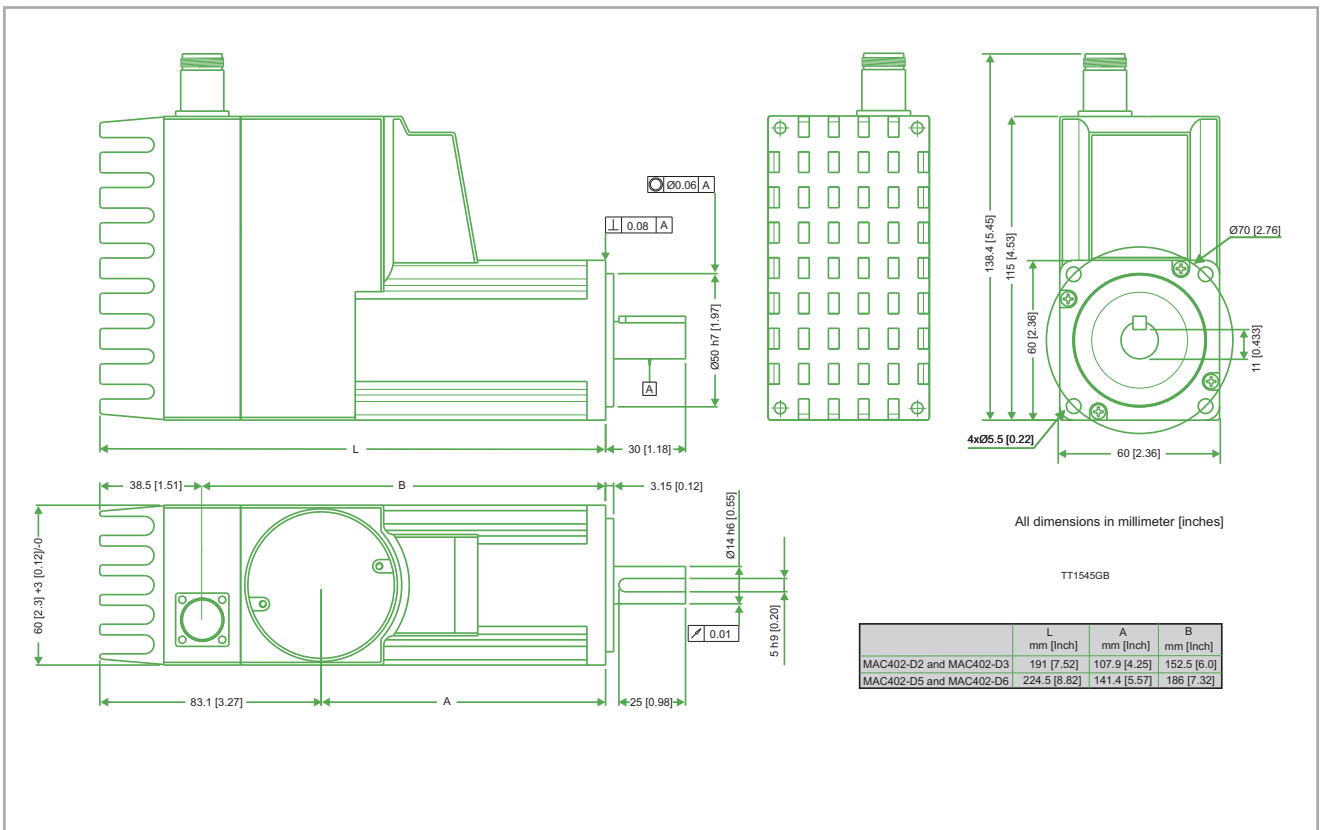

Mechanical dimensions MAC800

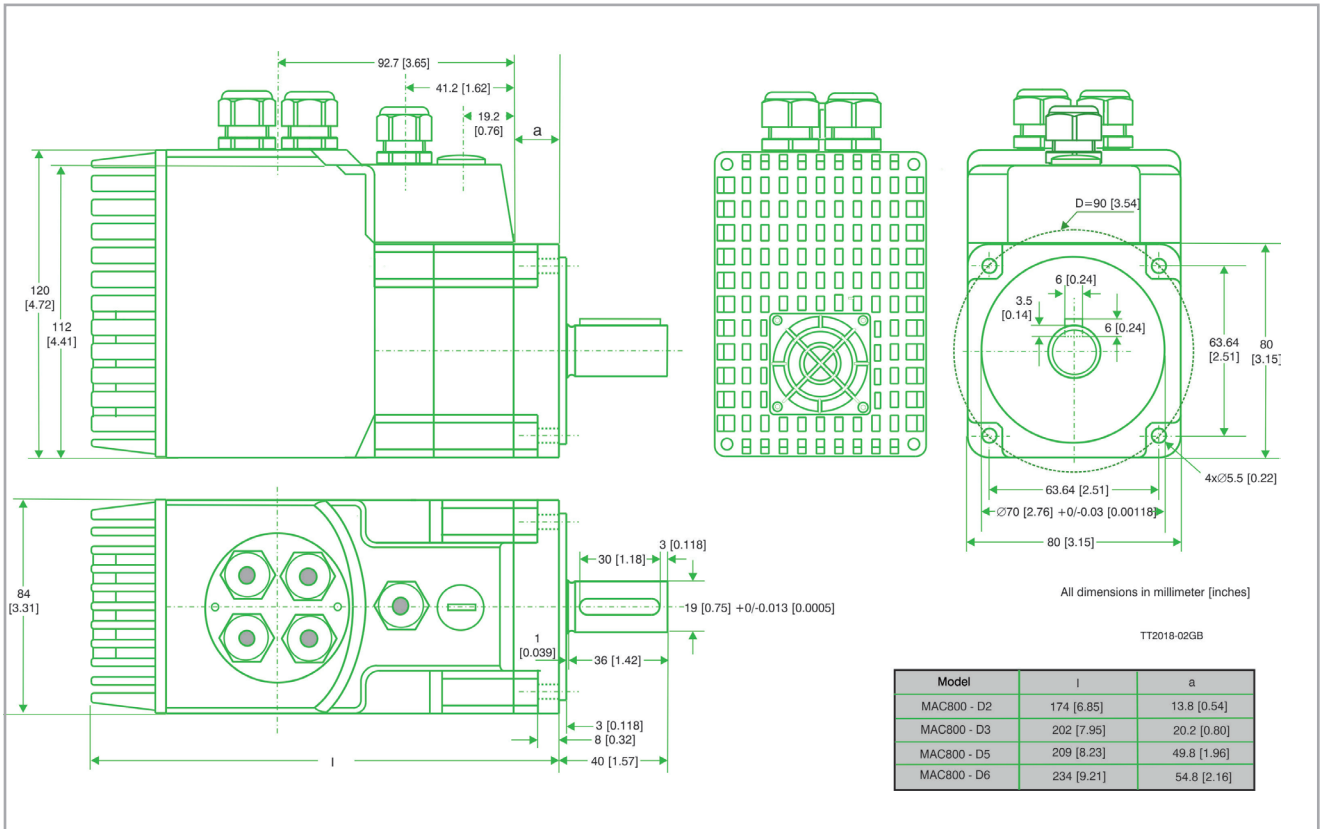

Mechanical dimensions MAC1500 and 3000

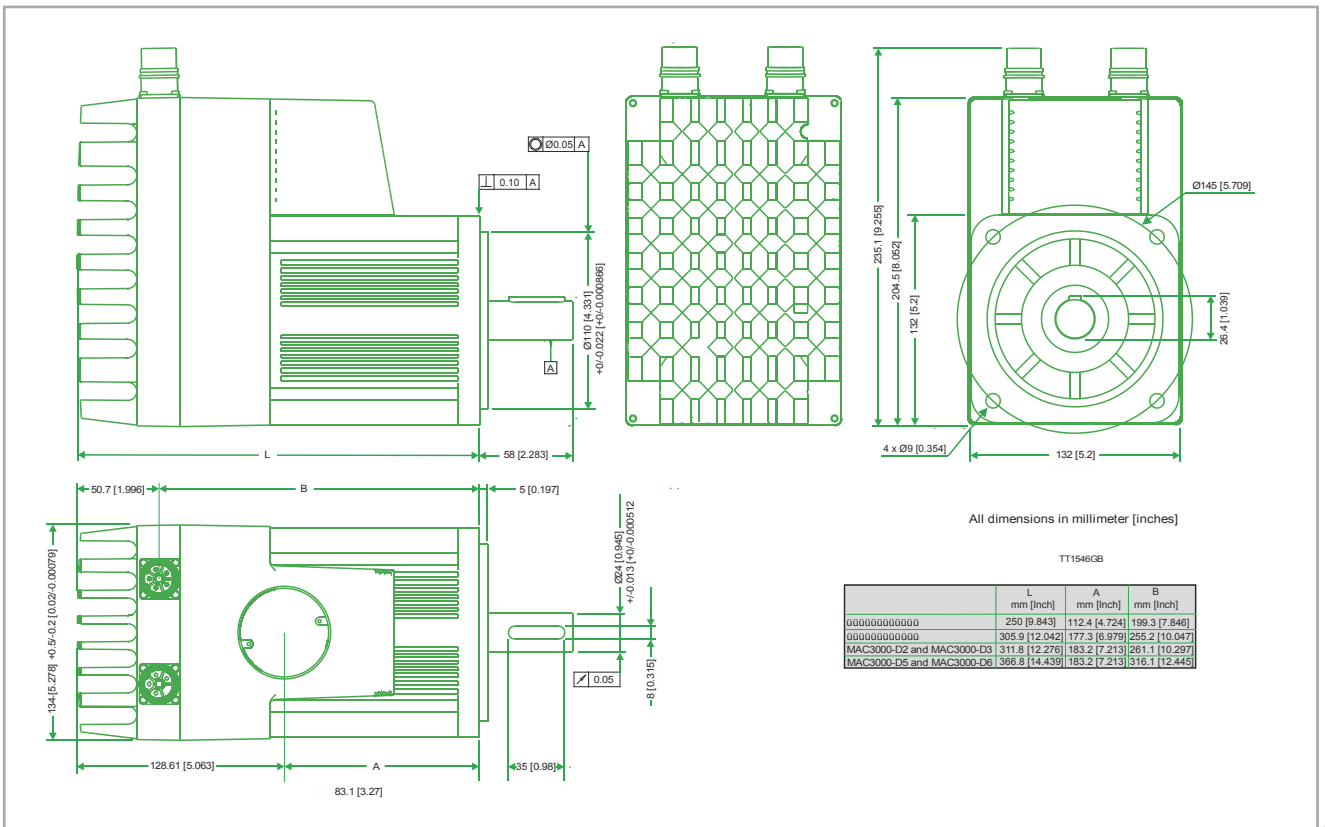

Planetary and cycloidal (robot) gearheads

JVL offers a wide range of both worm, planetary and cycloidal (robot) gears. They fit either directly or by means of adaptors on the MAC motors. gear ratios can be from 1:3 to 1:1000. Se separate datasheets for detailed information on our website: www.jvl.dk

- The advanges of using gearboxes:
- Sealed Ball Bearings
 - High Reliability, High Efficiency Design
 - Sealed Ball Bearings
 - High Reliability, High Efficiency Design
 - NEMA Mounting Standards
 - High Shaft Loading Capacity
 - Low Backlash Design

- Strong, Caged Roller Bearings
- Precision Input Pinion with Balanced Clamp Collar



MAC800 with HTRG gearbox

HTRG type gears:

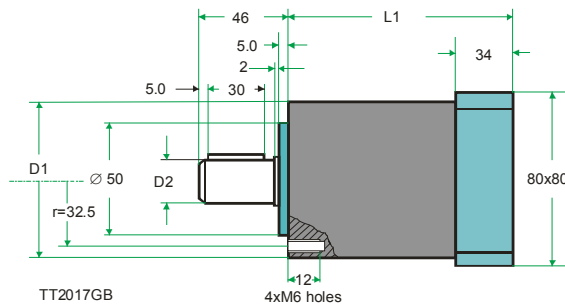

TT2017GB

4xM6 holes

HSPG type gears:

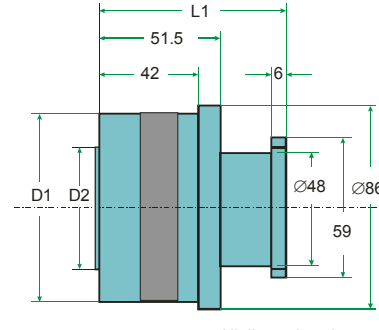

TT2010GB

All dimensions in mm

Model. HTRG	Gear ratio	Efficiency	Rated torque	Emerg. Torque	Inertia at motor shaft	Noise	Radial load	Axial load	Weight	L1	D1	D2
		[%]	[Nm]	[Nm]	[kg*cm ²]	[dB(A)]	[N]	[N]	[kg]	[mm]	[mm]	[mm]-(h7)
MAC400												
HTRG08N003MHP70119MC	3	97	18	70	0.11	<70	200	700	1.2	80,55	65	14
HTRG08N005MHP70119MC	5	97	25	90	0.37	<70	200	700	1.2	80,55	65	14
HTRG08N010MHP70119MC	10	97	25	90	0.29	<70	200	700	1.2	80,55	65	14
HTRG08N012MHP70119MC	12	94	30	100	0.56	<70	200	700	1.7	97,25	65	14
HTRG08N020MHP70119MC	20	94	70	250	0.36	<70	400	1400	4.6	142	85	19
MAC800												
HTRG08N003MHP70119MC	3	97	40	180	0.59	<70	400	1400	4	117.5	85	19
HTRG08N005MHP70119MC	5	97	50	200	0.37	<70	400	1400	4	117.5	85	19
HTRG08N010MHP70119MC	10	97	40	180	0.29	<70	400	1400	4	117.5	85	19
HTRG08N020MHP70119MC	20	94	70	250	0.36	<70	400	1400	4.6	142	85	19
HTRG08N100MHP70119MC	100	94	40	200	0.28	<70	400	1400	4.6	142	85	19
HTRG10N020MHP70119MC	20	94	170	600	0.93	<70	600	1600	6.5	180	106	25
HTRG13N100MHP70119MC	100	94	215	800	0.96	<70	800	6500	15.5	205	138	32
HTRG16N100MHP70119MC	100	94	350	1200	1.4	<70	1200	7500	21	229,5	155	40
HTRG19N100MHP70119MC	100	94	500	1400	3.3	<70	1400	15000	29	259,9	195	55
MAC1500-3000												
HTRG10N003MHS40224MC	3	97	100	360	2.2	<70	600	1600	6.5	167,5	106	25
HTRG10N005MHS40224MC	5	97	140	450	1.23	<70	600	1600	6.5	167,5	106	25
HTRG10N010MHS40224MC	10	97	100	360	0.85	<70	600	1600	6.5	167,5	106	25
HTRG13N100MHS40224MC	100	94	215	800	1.2	<70	800	6500	15.5	216	138	32
HTRG16N100MHS40224MC	100	94	350	1200	1.4	<70	1200	7500	21	229,5	155	40
HTRG19N100MHP70119MC	100	94	500	1400	3.3	<70	1400	15000	29	259,9	195	55

Backlash is 15 arcmin for all above HTRG gearboxes

Model. HSPG	Gear ratio	Efficiency	Rated torque	Emerg. Torque	Inertia at motor shaft	Noise	Radial load	Axial load	Weight	L1	D1	D2
		[%]	[Nm]	[Nm]	[kg*cm ²]	[dB(A)]	[N]	[N]	[kg]	[mm]	[mm]	[mm]-(h7)
HSPG110 (MAC400)	33,67,89,119	<82	122	610	0,16	-	9300	13100	3,76	-	110	-
HSPG140 (MAC800)	33,57,87,115,139,175	<82	268	1340	0,67	-	11500	17000	6,45	-	140	-
HSPG170 (MAC1K5-3K0)	33,59,83,105,141	<82	495	2475	1,15	-	19200	27900	11,07	-	170	-
HSPG200 (MAC1K5-3K0)	63,83,125,169	<82	890	4450	2,6	-	21100	31700	17,23	-	200	-

Backlash is <1 arcmin for all above HSPG gearboxes

These gearboxes are some examples of the types we often use. For other requests please contact JVL.dk.



Block diagram

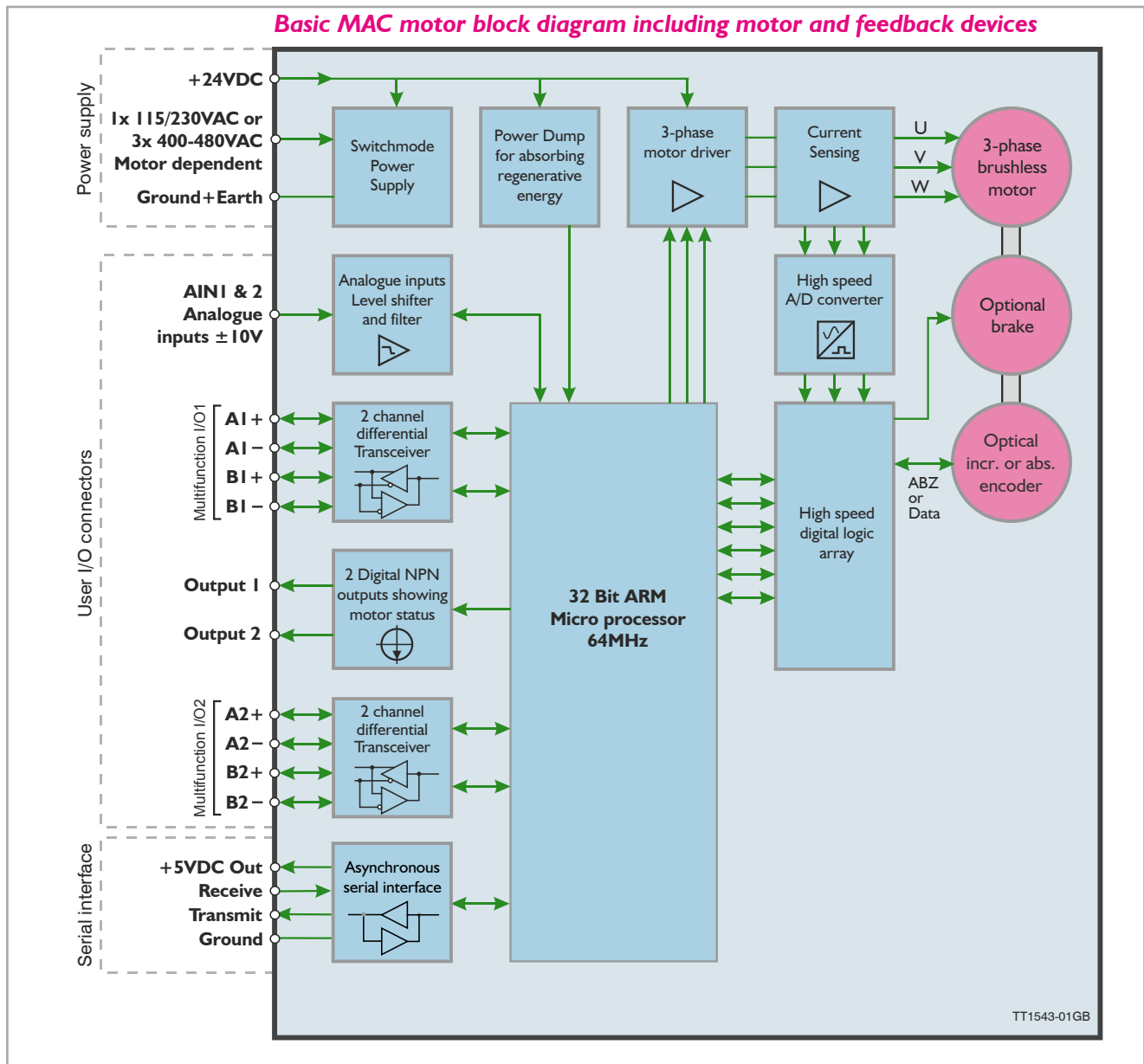

Optional absolute multiturn encoder

The absolute multi-turn encoder is an option with the MAC400, MAC800, MAC1500 and MAC3000 motors. The option offers the advantage that once the mechanical zero point is defined there will be no need for any Zero search or initialization sequence after power up since the motor always knows where it is with reference to

the original defined zero point regardless that power have been removed for shorter or longer time.

Please notice that ONLY MAC400, MAC800, MAC1500 and MAC3000 motors with the "F" extension contains this feature (MACxxx-yy-Fzzz). The built-in multi-turn encoder is

using a mechanical technology with the advantage that no battery is used to hold the position after power off. A battery needs replacement after a certain operating time or a certain number of charging and recharging cycles.



AC servo motors MAC400 -3000

Ordering information

MAC400 - D2 - XXXX

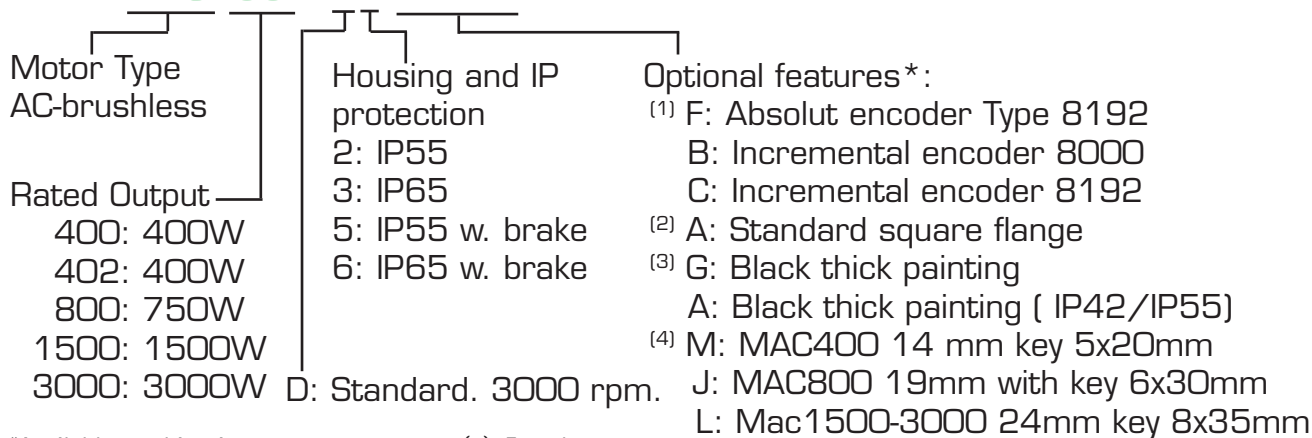

*Available combinations:
MAC400 and
MAC402: CAGM and FAGM
MAC800: BAAJ and FAAJ
MAC1500 and
MAC3000: CAAL and FAAL

For other options please contact JVL.

(1): Encoder type
(2): Flange
(3): Painting
(4): Shaft



MAC1500-D5 with brake

Accessories

RS232-9-1	Cable for PC
RS232-9-1-Mac	Cable for PC with built in RS232 converter
MacTalk	Software for set-up of Mac motor
MacRegIO	Expert tool for programmers
MacCommOCX	OCX/ActiveX driver for Windows
MAC00-xx	Expansion modules. See page 5
PSU24-075	24VDC Power Supply for control circuit
WP0203	Mains supply cable - 3m, 230VAC for MAC400
WP0303	Mains supply cable - 3m, 115VAC for MAC400
WP0102	Brake cable - 2m for MAC400
WP4102	MAC1500/3000 DC-bus/PD cable 2m 180°
WP4105	MAC1500/3000 DC-bus/PD cable 5m 180°
WP4110	MAC1500/3000 DC-bus/PD cable 10m 180°
RP1008	Power Dump resistor 47 Ohm/270W(18kW).
RS485	RS485 cables for different modules.



JVL Industri Elektronik A/S
Bregnerødvej 127
DK-3460 Birkerød, Denmark
Tel: +45 4582 4440
Fax: +45 4582 5550
E-mail: jvl@jvl.dk www.jvl.dk

JVL Turkey
Tel.: +90 216 3891644
email: ozkan.ozel@jvl.dk
www.jvl.dk

JVL USA
Tel.: +1 513 877 3134
E-mail: sales@jvlusa.com
www.jvlusa

JVL Deutschland
Tel.: +49 7121 1377260
E-mail: jan.tausend@jvl.dk
www.jvl drives.de

